

Gashähne MADEC

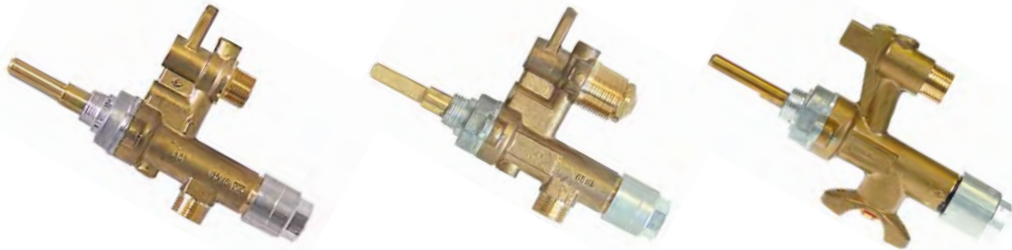

Seite 4

Gashähne PEL20/21



Seite 6

Gashähne PEL22/23



Seite 8

Gashähne EGA 26400/26440/24197



Seite 14

Gashähne EGA/PEL20/21/22



Seite 20

Gashähne JUNKERS



Seite 24

G
Gashähne

Gashähne STN3R



Seite 26

Gashähne COPRECI



Seite 27

Gashähne SABAF



Seite 28

Diverse Gashähne



Seite 29

Gashähne MADEC

© GEV 2007

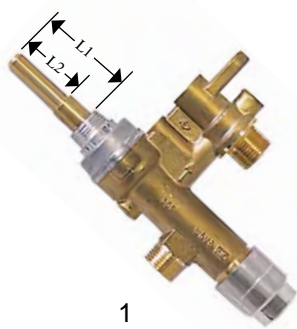

1



2



3

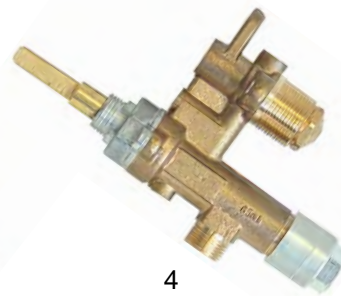

4

Abb.	Bestell-Nr.	Beschreibung	Gaseingang	ø Düsen (mm)			Mischrohr-anschluss	Rohr		Thermoelement-anschluss	Front-befestigung	L1/L2 (mm)	Achse (mm)
				Außen-düse	Innen-düse	Kleinbrand-düse		Ausgang	ø (mm)				
1	101629	Rohrausgang	M12x1 (8mm)	-	-	0,55	-	M12x1	8	M8x1	M12x1	29,5/21	
	101638		M12x1 (8mm)	-	-	1,00	-	M12x1	8	M8x1	M12x1	29,5/21	
2	101074		M12x1 (8mm)	-	-	0,35	-	M12x1	8	M8x1	M12x1	29,5/21	
	101072		M12x1 (8mm)	-	-	0,35	-	M12x1	8	M8x1	M12x1	29,5/13,5	
	101193		M12x1 (8mm)	-	-	0,35	M17x1	-	-	M8x1	M12x1	23/13,5	
	101073		M12x1 (8mm)	-	-	0,35	M17x1	-	-	M8x1	M12x1	23/13,5	
3	106034	Düsenausgang ohne Düse	M12x1 (8mm)	-	-	0,35	M17x1	-	-	M8x1	M12x1	29,5/13,5	
	106174		M12x1 (8mm)	-	-	0,35	M17x1	-	-	M8x1	M12x1	23/13,5	
	101194		M12x1 (8mm)	-	-	0,35	M17x1	-	-	M8x1	M12x1	17/9	
	101635		M12x1 (8mm)	-	-	0,55	M17x1	-	-	M8x1	M12x1	37/17	
	101374		M12x1 (8mm)	0,85	-	0,50	M17x1	-	-	M8x1	M12x1	29,5/21	
	101198		M12x1 (8mm)	2,00	0,70	0,35	M17x1	-	-	M8x1	M12x1	29,5/21	
4	101381	Düsenausgang mit Düse	M12x1 (8mm)	0,85	-	0,50	M17x1	-	-	M8x1	M12x1	29,5/21	
	101631		M12x1 (8mm)	2,20	1,20	0,55	M17x1	-	-	M8x1	M12x1	37/17	

G
Gashähne



Abb.	Bestell-Nr.	Beschreibung	Gaseingang	ø Düsen (mm)			Mischrohr-anschluss	Rohr-Ausgang ø (mm)	Thermoelement-anschluss	Front-befestigung	L1/L2 (mm)	Achse (mm)	
				Außen-düse	Innen-düse	Klein-branddüse							
1	101192	Düsenausgang ohne Düse	M12x1(8mm)	-	-	-	M17x1	-	-	M8x1	M12x1	23/13,5	
	106019	Düsenausgang mit Düse	M12x1(8mm)	-	-	-	M17x1	-	-	M8x1	-	29,5/13,5	
3	106020	Rohrausgang mit Schellenanschluss ø 21mm	Flanschanschluss	-	-	1,40	-	M12x1	8mm	M8x1	M12x1	29/20	
4	106057	Rohrausgang mit Schellenanschluss ø 21mm	Flanschanschluss	-	-	0	-	M12x1	8mm	M8x1	-	27/15	

Zubehör und Ersatzteile

Außendüsen M12x1

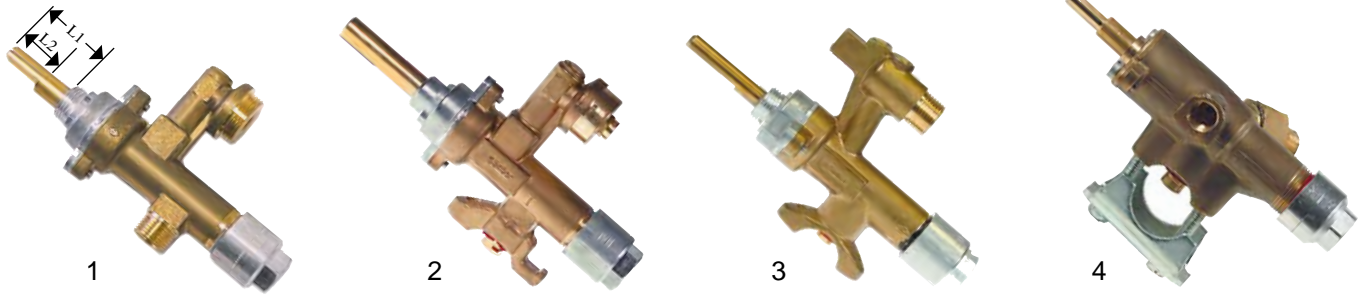

Pos.	Bestell-Nr.	ø (mm)	Pos.	Bestell-Nr.	ø (mm)	Pos.	Bestell-Nr.	ø (mm)
1	100974	0,80	18	100287	1,45	35	100309	2,30
2	100279	0,82	19	100700	1,50	36	100668	2,35
3	100249	0,85	20	100301	1,55	37	100294	2,40
4	100283	0,90	21	100665	1,60	38	100749	2,45
5	100280	0,93	22	100239	1,65	39	100326	2,50
6	100282	0,95	23	100288	1,70	40	100416	2,55
7	100284	1,00	24	100878	1,75	41	100304	2,60
8	100662	1,05	25	100289	1,80	42	100295	2,70
9	100285	1,10	26	100302	1,85	43	100305	3,00
10	100243	1,12	27	100290	1,90	44	100752	3,20
11	100663	1,15	28	100740	1,95	45	100296	3,30
12	100306	1,20	29	100291	2,00	46	100297	3,45
13	100975	1,25	30	100303	2,05	47	100298	3,50
14	100286	1,30	31	100292	2,10	48	100299	3,70
15	100300	1,35	32	100744	2,12	49	100763	3,80
16	100669	1,37	33	100308	2,15	50	102794	3,85
17	100307	1,40	34	100293	2,20	51	100762	4,10

Innendüsen



Pos.	Bestell-Nr.	ø (mm)	Pos.	Bestell-Nr.	ø (mm)	Pos.	Bestell-Nr.	ø (mm)
1	100325	0,70	5	100788	0,95	9	100423	1,40
2	100419	0,75	6	100449	1,00	10	100771	1,55
3	100421	0,80	7	100422	1,20	11	100770	1,65
4	100774	0,85	8	100772	1,30			

Kleinbranddüsen



Pos.	Bestell-Nr.	ø (mm)	Pos.	Bestell-Nr.	ø (mm)	Pos.	Bestell-Nr.	ø (mm)
1	100360	0,35	4	100426	0,55	7	100424	0,80
2	100425	0,45	5	100781	0,60	8	100454	1,00
3	100782	0,50	6	100427	0,70			



Abb.	Bestell-Nr.	Beschreibung	Abb.	Bestell-Nr.	Beschreibung
1	101277	Doppelkonus für Rohr ø 8mm	4	101051	Magneteinsatz
2	101296	Überwurfmutter M12x1 für Rohr ø 8mm	5	101234	Magneteinsatzmutter M8x1
3	101299	Frontbefestigungsmutter M12x1			



Abb.	Bestell-Nr.	Beschreibung	Abb.	Bestell-Nr.	Beschreibung
1	101400	Mischrohr M17x1	3	101394	Mutter M17x1
2	101401	Mischrohr M17x1			

Gashähne PEL20/21

© GEV 2007



Abb.	Bestell-Nr.	Beschreibung	Gaseingang	ø Rohreingang (mm)	ø Kleinbranddüse (mm)	Gasausgang	ø Rohrausgang (mm)	Thermoelementanschluss (mm)	L1/L2 (mm)	Achse (mm)
1	101398	PEL20N ohne Sicherheit, ohne Zündflamme	M16x1,5	10	0,35	M16x1,5	10/8	-	22/15	
	101094		M16x1,5	10	0,35	M16x1,5	10/8	M8x1	22/15	
2	101491	PEL20S mit Sicherheit, ohne Zündflamme	M16x1,5	10	0,35	M16x1,5	10/8	M9x1	22/15	
	101958		M16x1,5	10	0	M16x1,5	10/8	M8x1	39/15	





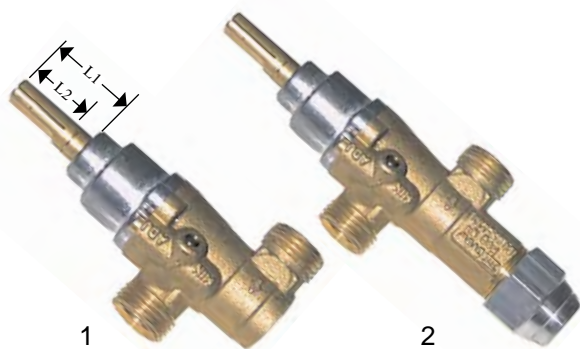

Abb.	Bestell-Nr.	Beschreibung	Gaseingang	ø Rohreingang (mm)	ø Kleinbranddüse (mm)	Gasausgang	ø Rohrausgang (mm)	Thermoelementanschluss (mm)	L1/L2 (mm)	Achse (mm)
1	101530	PEL21N ohne Sicherheit, mit Zündflamme	M16x1,5	10	0,35	M16x1,5	10/8	-	22/15	
	101693		M16x1,5	10	0,70	M16x1,5	10/8	M8x1	35/28	
	101913		M16x1,5	10	0,90	M16x1,5	10/8	M8x1	35/28	
	101095		M16x1,5	10	0,35	M16x1,5	10/8	M8x1	22/15	
	101356		M16x1,5	10	0,35	M16x1,5	10/8	M10x1	22/15	
	101883		M16x1,5	10	0,40	M16x1,5	10/8	M8x1	22/15	
	101884		M16x1,5	10	0,50	M16x1,5	10/8	M8x1	22/15	
2	101885	PEL21S mit Sicherheit, mit Zündflamme	M16x1,5	10	0,80	M16x1,5	10/8	M8x1	22/15	
	106021		M16x1,5	10	0,95	M16x1,5	10/8	M8x1	22/15	
	101397		M16x1,5	10	0,35	M16x1,5	10/8	M9x1	22/15	
	101917		M16x1,5	10	0,60	M16x1,5	10/8	M9x1	22/15	
	101918		M16x1,5	10	0,65	M16x1,5	10/8	M9x1	22/15	
	101919		M16x1,5	10	0,75	M16x1,5	10/8	M9x1	22/15	
3	106138		M16x1,5	10	0	M10x1	6	M9x1	37/15	

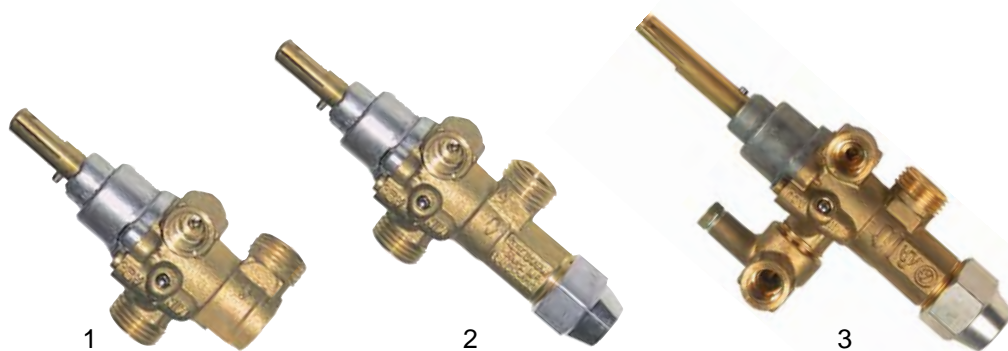

Abb.	Bestell-Nr.	Beschreibung	ø Gaseingang (mm)	ø Kleinbranddüse (mm)	Gasausgang	ø Rohrausgang (mm)	Thermoelementanschluss (mm)	L1/L2 (mm)	Achse (mm)
1	101897	PEL21S mit Sicherheit, mit Zündflamme	21	0,35	M16x1,5	10/8	M8x1	32/25	
	101544		21	0,35	M16x1,5	10/8	M8x1	30/23	
	101610		21	0,35	M16x1,5	10	M8x1	30/23	
	101671		21	0,35	M17x1	10	M8x1	30/23	
2	101672	PEL21S mit Sicherheit, mit Zündflamme	21	0,85	M17x1	10	M8x1	30/23	
	101976		21	0,35	M17x1	10	M8x1	30/17,5	
	101682		21	0,35	M17x1	10	M8x1	31/15	
3	106143	PEL20 mit Sicherheit, ohne Zündflamme	21	0,35	M16x1,5	10/8	M9x1	22/15	





Abb.	Bestell-Nr.	Beschreibung	ø Gaseingang (mm)	ø Kleinbranddüse (mm)	Gasausgang	ø Rohrausgang (mm)	Thermoelementanschluss (mm)	L1/L2 (mm)	Achse (mm)
1	106144	PEL21N ohne Sicherheit, mit Zündflamme	21	0,35	M16x1,5	10/8	-	22/15	
	106231	PEL21S mit Sicherheit, mit Zündflamme	21	1,05	M16x1,5	10/8	M8x1	22/15	
2	106145	PEL21S mit Sicherheit, mit Zündflamme	21	0,35	M16x1,5	10/8	M9x1	22/15	
	101611	PEL21S V mit Sicherheit, mit Zündflamme	21	0,35	M16x1,5	10/8	M8x1	30/17,5	
3	106060	PEL21S H mit Sicherheit, mit Zündflamme	21	0	M16x1,5	10	M8x1	45/19	

Gashähne PEL22

PEL22N ohne Sicherheit

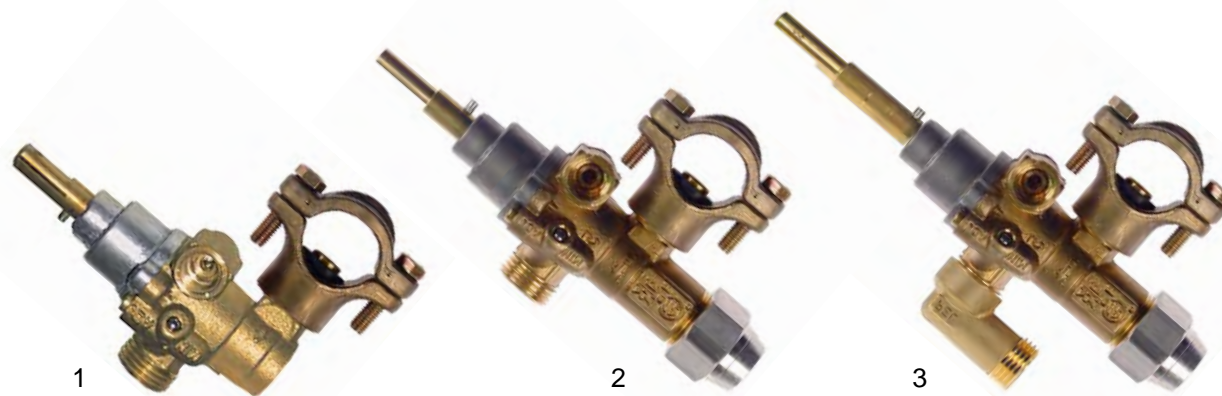

Abb.	Bestell-Nr.	Beschreibung	Gaseingang	ø Rohreingang (mm)	ø Kleinbranddüse (mm)	Gasausgang	ø Rohrausgang (mm)	L1/L2 (mm)	Achse (mm)
1	101443	PEL22N/O	M20x1,5	12	0,35	M20x1,5	12/10	25/17	
	106233	PEL22N/O	M20x1,5	12	0,35	M20x1,5	12/10	28/13	
2	106234	PEL22N/O	M20x1,5	12	0,35	M20x1,5 (gebördelte Leitung)	12/10	28/13	
	101690	PEL22N/V	M20x1,5	12	0,35	M20x1,5	12/10	25/17	
3	106169	PEL22N/V	M20x1,5	12	0,35	M20x1,5	12/10	45/20	
	101459	PEL22N/O	ø 21mm	-	0,35	M20x1,5	12	39/7	
4	106157	PEL22N/O	ø 27mm	-	0,35	M20x1,5	14	39/7	

Gashähne PEL22S mit Sicherheit

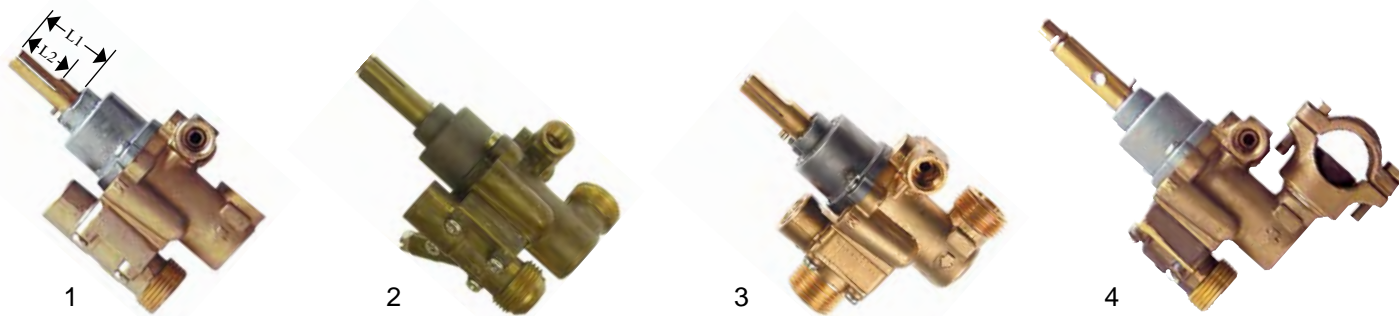

Abb.	Bestell-Nr.	Beschreibung	Gaseingang	ø Rohreingang (mm)	ø Kleinbranddüse (mm)	Gasausgang	ø Rohrausgang (mm)	Thermoelementanschluss	L1/L2 (mm)	Achse (mm)
	101084	PEL22S/V	M20x1,5	12	0,35	M20x1,5	12/10	M8x1	45/20	
	101157	PEL22S/V	M20x1,5	12	0,35	M20x1,5	12/10	M8x1	25/17	
	101341	PEL22S/V	M20x1,5	12	0,35	M20x1,5	12/10	M10x1	25/17	
1	101457	PEL22S/V	M20x1,5	12	0,35	M20x1,5	12/10	M8x1	25/-	
	101798	PEL22S/V	3/8"	-	0,35	3/8"	-	M10x1	25/-	
	101793	PEL22S/V	M20x1,5	12	0,90	M20x1,5	12/10	M8x1	45/20	
	101087	PEL22S/V	M20x1,5	12	0,35	M20x1,5	12/10	M9x1	25/17	
	106073	PEL22S/V	M20x1,5	12	0,35	M20x1,5	12/10	M8x1	35/17	
	101981	PEL22S/V	M20x1,5	12	0	M20x1,5	12/10	M9x1	34/26	
2	101887	PEL22S/V	M20x1,5	12	0	M20x1,5	12/10	M9x1	25/17	
3	107200	PEL22S/V	M20x1,5	12	0	M20x1,5	12/10	M9x1	16/7	

PEL22S/O, Ausgang horizontal, mit Sicherheit





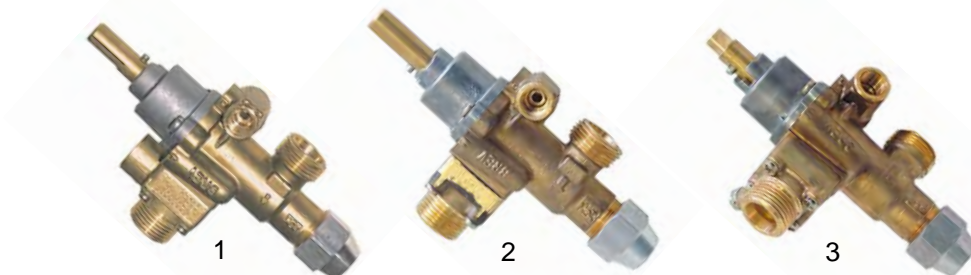





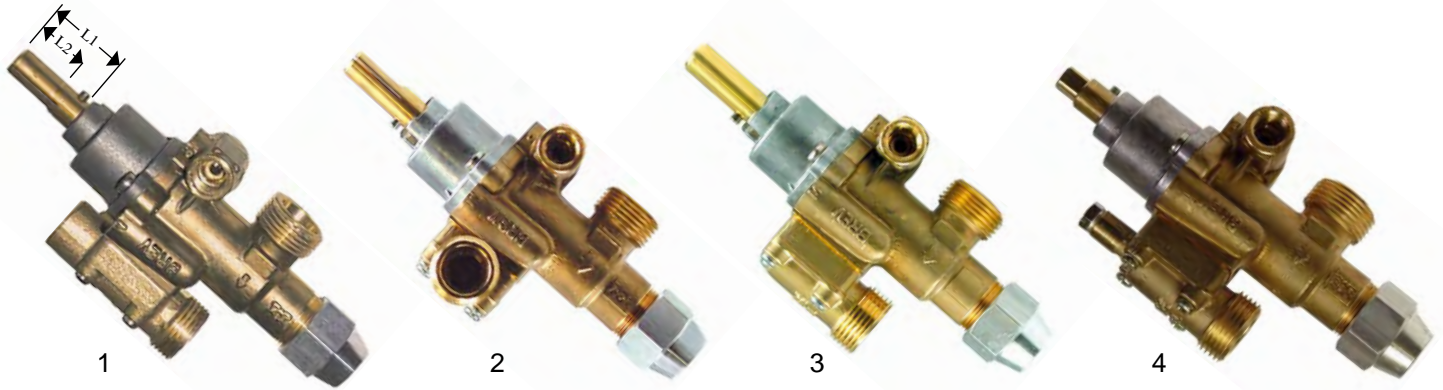







Abb.	Bestell-Nr.	Beschreibung	Gaseingang	ø Rohreingang (mm)	ø Kleinbranddüse (mm)	Gasausgang	ø Rohrausgang (mm)	Thermoelementanschluss	L1/L2 (mm)	Achse (mm)
	101086	PEL22S/O	M20x1,5	12	0,35	M20x1,5	12/10	M9x1	25/17	
	101510	PEL22S/O	M20x1,5	12	0	M20x1,5	12/10	M9x1	25/17	
	101089	PEL22S/O	M20x1,5	12	0,35	M20x1,5	12/10	M8x1	25/17	
	109510	PEL22S/O	M20x1,5	12	1,30	M20x1,5	12/10	M8x1	25/17	
1	109513	PEL22S/O	M20x1,5	12	1,10	M20x1,5	12/10	M8x1	25/17	
	101085	PEL22S/O	M20x1,5	12	0,35	M20x1,5	12/10	M8x1	28/13	
	101090	PEL22S/O	M20x1,5	12	0,35	M20x1,5	12/10	M8x1	28/13	
	106022	PEL22S/O	M20x1,5	12	0,35	M20x1,5	12/10	M8x1	45/20	
	106056	PEL22S/O	M20x1,5	12	0,35	M20x1,5	12/10	M10x1	45/20	
	101949	PEL22S/O	M20x1,5	12	0	M20x1,5	12/10	M9x1	25/17	
2	101892	PEL22S/O	M20x1,5	12	0,35	M20x1,5	12/10	M9x1	25/17	
	106023	PEL22S/O	M20x1,5	12	0	M20x1,5	12/10	M8x1	29/19,5	
3	101950	PEL22S/O	M20x1,5	12	0,35	M20x1,5	12/10	M9x1	25/17	
	107201	PEL22S/O	M20x1,5	12	0	M20x1,5	12/10	M9x1	16/7	
4	106159	PEL22S/O	M20x1,5	12	0	M20x1,5	12/10	M9x1	47/21	

PEL22 mit Sicherheit, und mit Rohranschluss



Abb.	Bestell-Nr.	Beschreibung	ø Gaseingang (mm)	ø Kleinbranddüse (mm)	Gasausgang	ø Rohrausgang (mm)	Thermoelementanschluss	L1/L2 (mm)	Achse (mm)
1	101626	PEL22S/O	27	0,35	M20x1,5	12/10	M8x1	35/21	
	101469	PEL22S/O	21	0,35	M20x1,5	12	M9x1	39/7	
	101489	PEL22S/O	27	0,35	M20x1,5	14	M8x1	39/7	
2	101661	PEL22S/V	21	0,35	M20x1,5	12/10	M8x1	28/13	

PEL23S mit Sicherheit

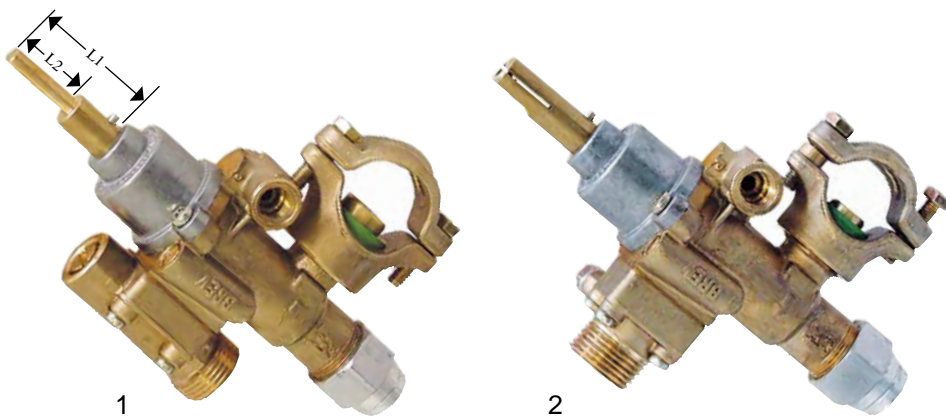

Abb.	Bestell-Nr.	Beschreibung	Gaseingang	ø Rohreingang (mm)	ø Kleinbranddüse (mm)	Gasausgang	ø Rohrausgang (mm)	Thermoelementanschluss	L1/L2 (mm)	Achse (mm)
1	101893	PEL23S/O	M28x1,5	20	0,35	M24x1,5	16/12	M9x1	25/17	
	106033	PEL23S/O	M28x1,5	20	0,35	M24x1,5	16/12	M10x1	25/17	
	101954	PEL23S/O	M28x1,5	20	1,70	M24x1,5	16/12	M10x1	25/17	
	101092	PEL23S/O	M28x1,5	20	0,35	M24x1,5	16/12	M10x1	25/17	
	101091	PEL23S/O	M28x1,5	20	0,35	M24x1,5	16/12	M9x1	35/19	
2	101953	PEL23S/V	M28x1,5	20	1,15	M24x1,5	16/12	M10x1	25/17	
	101093	PEL23S/V	M28x1,5	20	0,35	M24x1,5	16/12	M10x1	25/17	
	101630	PEL23S/V	1/2" IG	-	0,35	1/2" AG	-	M10x1	25/-	

Zubehör und Ersatzteile für PEL20/21

Kleinbranddüsen

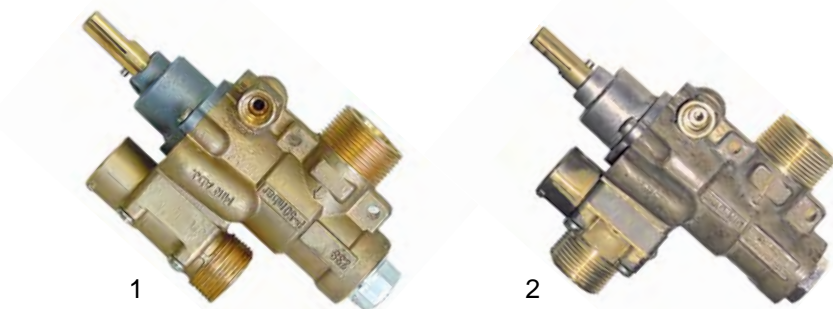

Pos.	Bestell-Nr.	ø (mm)	Pos.	Bestell-Nr.	ø (mm)	Pos.	Bestell-Nr.	ø (mm)
1	106202	0	10	100278	0,75	19	100532	1,20
2	100408	0,35	11	100555	0,80	20	100394	1,25
3	100553	0,40	12	100527	0,85	21	100533	1,30
4	100554	0,45	13	100528	0,90	22	100549	1,35
5	100526	0,50	14	100556	0,95	23	100534	1,40
6	100550	0,55	15	100529	1,00	24	100558	1,55
7	100551	0,60	16	100557	1,05	25	100559	1,70
8	100548	0,65	17	100530	1,10	26	100547	1,75
9	100552	0,70	18	100531	1,15			



Abb.	Bestell-Nr.	Beschreibung	Gewinde	ø Rohr (mm)
	101451	Überwurfmutter	M16x1,5	8
1	101300	Überwurfmutter	M16x1,5	10
	100943	Überwurfmutter	M17x1	10
2	101450	Doppelkonus	-	8
	101278	Doppelkonus	-	10
3	106168	Lötanschluss	-	10
4	100908	Überwurfschraube	M10x1	4
	100909	Überwurfschraube	M10x1	6
5	101246	Doppelkonus	-	4
6	101286	Doppelkonus	-	6
7	101880	Dichtung für Rohrflansch ø 21mm	-	-

Vorderteile



Abb.	Bestell-Nr.	Typ	L1/L2 (mm)	Achse (mm)
1	101205	PEL20	22/15	
	106156	PEL20	39/15	
	101206	PEL21	22/15	
	101875	PEL21	32/25	
	106147	PEL21	37/15	
2	101874	PEL21	22/15	
	101803	PEL21	30/23	
	101804	PEL21	30/17,5	
	106149	PEL21	45/19	
	106146	PEL21	35/28	
	101808	PEL21	31/15	



Abb.	Bestell-Nr.	Beschreibung	Gewinde	Abb.	Bestell-Nr.	Beschreibung	Gewinde
1	101230	Magnetmutter	M8x1	1	101290	Magnetmutter	M10x1
	101231	Magnetmutter	M9x1	2	101060	Magneteinsatz	-

Zubehör und Ersatzteile für PEL22

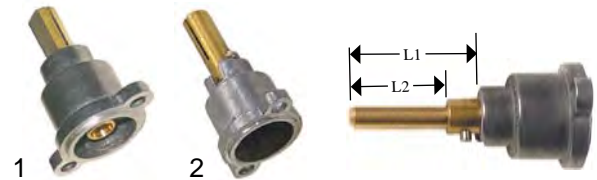
Kleinbranddüsen



Pos.	Bestell-Nr.	ø (mm)	Pos.	Bestell-Nr.	ø (mm)	Pos.	Bestell-Nr.	ø (mm)
1	106191	0	8	100428	0,65	15	100407	1,00
2	100259	0,35	9	100429	0,70	16	100435	1,05
3	100281	0,40	10	100432	0,75	17	100436	1,10
4	100414	0,45	11	100409	0,80	18	100437	1,15
5	100390	0,50	12	100410	0,85	19	100438	1,20
6	100391	0,55	13	100433	0,90	20	100413	1,65
7	100392	0,60	14	100434	0,95	21	100776	1,75



Abb.	Bestell-Nr.	Beschreibung	Gewinde	ø Rohr (mm)
1	101240	Gasanschlusssteil horizontal	M20x1,5	12/10
2	101241	Gasanschlusssteil vertikal	M20x1,5	12/10
3	101235	Gasanschlusssteil horizontal	M20x1,5	12/10
4	101236	Gasanschlusssteil vertikal	M20x1,5	12/10
5	101365	Gasanschlusssteil horizontal	M20x1,5	12
	101366	Gasanschlusssteil horizontal	M20x1,5	14



Abb.	Bestell-Nr.	Beschreibung
1	101461	Schraubensatz
2	101460	O-Ring
3	101331	Adapter für gebördelte Leitung
4	101536	Dichtung für Rohrflansch ø 21mm
	106165	Dichtung für Rohrflansch ø 27mm

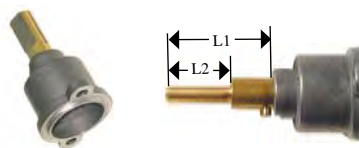

Pos.	Bestell-Nr.	L1/L2 (mm)	Achse (mm)
1	101201	25/17	
2	101449	35/17	
3	101873	34/26	
4	101202	25/17	
5	101203	28/13	
6	101200	25/-	
7	106162	16/7	
8	106163	47/-	
9	101823	35/21	
10	106154	29/19,5	
11	101214	45/20	
12	101213	45/20	
13	106151	39/7	
14	106152	39/7	



Pos.	Bestell-Nr.	Beschreibung	Gewinde	ø Rohr (mm)
1	101250	Überwurfmutter	M20x1,5	10
	101251	Überwurfmutter	M20x1,5	12
	101427	Überwurfmutter	M20x1,5	14
2	101249	Doppelkonus	-	10
3	101248	Doppelkonus	-	12
	101428	Doppelkonus	-	14
4	101531	Lötanschluss	-	12
5	100908	Überwurfschraube	M10x1	4
	100909	Überwurfschraube	M10x1	6
6	101246	Doppelkonus	-	4
7	101286	Doppelkonus	-	6



Abb.	Bestell-Nr.	Beschreibung	Gewinde	Abb.	Bestell-Nr.	Beschreibung	Gewinde
1	101230	Magnetmutter	M8x1	1	101290	Magnetmutter	M10x1
	101231	Magnetmutter	M9x1	2	101058	Magneteinsatz	-

Zubehör und Ersatzteile für PEL23

Kleinbranddüsen



Pos.	Bestell-Nr.	ø (mm)	Pos.	Bestell-Nr.	ø (mm)	Pos.	Bestell-Nr.	ø (mm)
1	106201	0	12	100598	0,95	23	100679	1,50
2	100455	0,35	13	100627	1,00	24	100699	1,55
3	106235	0,40	14	100628	1,05	25	100250	1,60
4	100448	0,50	15	100649	1,10	26	100251	1,65
5	100458	0,60	16	100655	1,15	27	100263	1,70
6	100459	0,65	17	100659	1,20	28	100264	1,75
7	100493	0,70	18	100664	1,25	29	100265	1,80
8	100494	0,75	19	100666	1,30	30	100266	1,85
9	100497	0,80	20	100667	1,35	31	100267	1,90
10	100546	0,85	21	100674	1,40	32	100268	1,95
11	100597	0,90	22	100677	1,45	33	100273	2,00



Abb.	Bestell-Nr.	Beschreibung	Gewinde	ø Rohr (mm)
1	101252	Überwurfmutter	M24x1,5	12
1	101253	Überwurfmutter	M24x1,5	16
1	101254	Überwurfmutter	M28x1,5	20
2	101255	Klemmring	-	12
3	101256	Klemmring	-	16
3	101257	Klemmring	-	20
4	100908	Schraube	M10x1	4
4	100909	Schraube	M10x1	6
5	101246	Klemmring	-	4
6	101286	Klemmring	-	6



Abb.	Bestell-Nr.	Beschreibung	Gewinde	ø Rohr (mm)
1	101244	Gasanschlusssteil horizontal	M24x1,5	16/12
2	101245	Gasanschlusssteil vertikal	M24x1,5	16/12
3	101463	Schraubensatz	-	-
4	101462	O-Ring	-	-

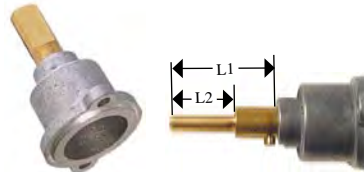

Pos.	Bestell-Nr.	L1/L2 (mm)	Achse (mm)
1	101204	25/17	
2	101336	35/19	
3	106166	25/17	
4	102767	25/-	



Pos.	Bestell-Nr.	Beschreibung	Gewinde	Pos.	Bestell-Nr.	Beschreibung	Gewinde
1	101059	Magneteinsatz	M10x1	2	101045	Magneteinsatz	M9x1

Gashähne EGA

EGA 31849 mit Rohrausgang

EGA 31248 mit Rohrausgang und Düsenausgang

EGA 30750 mit Rohrausgang



Abb.	Bestell-Nr.	Ersatz-Nr.	Typ EGA	Beschreibung	Gaseingang	ø Düsen (mm)			Mischrohr-anschluss	Rohrausgang	Thermoelement-anschluss	Frontbefestigung	L1/L2 (mm)	Achse (mm)
						Außendüse	Innendüse	Kleinbranddüse						
1	nml*	101629	31849	Gashahn mit Rohrausgang	M12x1 (8mm)	-	-	0,55	-	M12x1 (8mm)	M8x1	M12x1	29,5/21	
	nml*	101638	31849		M12x1 (8mm)	-	-	1,00	-	M12x1 (8mm)	M8x1	M12x1	29,5/21	
2	nml*	101074	31248	Gashahn	M12x1 (8mm)	-	-	0,35	-	M12x1 (8mm)	M8x1	M12x1	29,5/21	
	nml*	101072	31248		M12x1 (8mm)	-	-	0,35	-	M12x1 (8mm)	M8x1	M12x1	29,5/13,5	
3	nml*	101193	31248	Gashahn	M12x1 (8mm)	-	-	0,35	M17x1	-	M8x1	M12x1	23/13,5	
	nml*	101073	31248		M12x1 (8mm)	-	-	0,35	M17x1	-	M8x1	M12x1	23/13,5	
4	nml*	106034	31248	Gashahn mit Düsenausgang, mit Düsen	M12x1 (8mm)	-	-	0,35	M17x1	-	M8x1	M12x1	29,5/13,5	
	nml*	106174	31248		M12x1 (8mm)	-	-	0,35	M17x1	-	M8x1	M12x1	23/13,5	
5	nml*	101194	31248	Gashahn mit Rohrausgang	M12x1 (8mm)	-	-	0,35	M17x1	-	M8x1	M12x1	17/9	
	nml*	101635	31248		M12x1 (8mm)	-	-	0,55	M17x1	-	M8x1	M12x1	37/17	
6	nml*	101374	31248	Gashahn mit Rohrausgang	M12x1 (8mm)	0,85	-	0,50	M17x1	-	M8x1	M12x1	29,5/21	
	nml*	101198	31248		M12x1 (8mm)	2,00	0,70	0,35	M17x1	-	M8x1	M12x1	29,5/21	
7	nml*	101381	31248	Gashahn mit Rohrausgang	M12x1 (8mm)	0,85	-	0,50	M17x1	-	M8x1	M12x1	29,5/21	
	nml*	101631	31248		M12x1 (8mm)	2,20	1,20	0,55	M17x1	-	M8x1	M12x1	37/17	
8	nml*	101632	31248	Gashahn mit Rohrausgang	M12x1 (8mm)	2,20	1,40	0,70	M17x1	-	M8x1	M12x1	37/17	
	5	101473	30750		M12x1 (8mm)	-	-	0,50	-	M12x1 IG (8mm)	M8x1	M12x1	22/19	







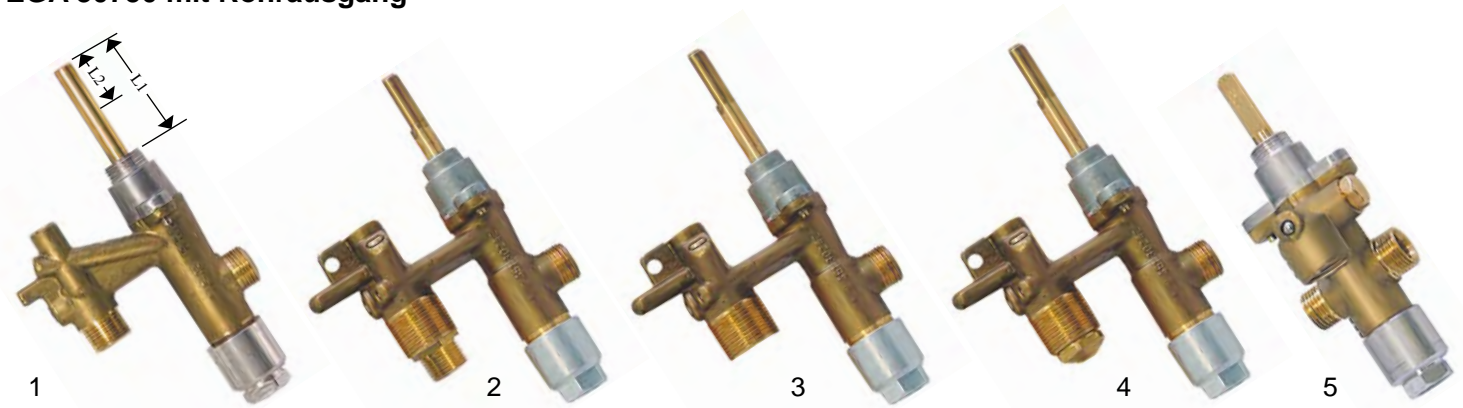



*nicht mehr lieferbar

Gashähne

EGA 26400 mit Rohrausgang, ohne Zündflammenanschluss

EGA 26440 mit Rohrausgang, mit Zündflammenanschluss



Abb.	Bestell-Nr.	Ersatz-Nr.	Typ EGA	Gaseingang	ø Rohreingang (mm)	ø Kleinbrand-düse (mm)	Gasausgang	ø Rohrausgang (mm)	Thermoelement-anschluss	L1/L2 (mm)	Achse (mm)	
1	nml*	101603	26400R	M15x1	10	0,35	M17x1	10	M8x1	31/23		
	nml*	101608	26400R	M15x1	10	0,35	M17x1	10	M8x1	34/15		
	nml*	101616	26400R	M15x1	10	0,35	M17x1	10	M8x1	31/15		
	nml*	-	26400R	M15x1	10	0,35	M17x1	10	M8x1			
2	nml*	101648**	26400RD	M15x1	10	0,35	M17x1	10	M8x1	31/23		
	nml*	101605	26440R	M15x1	10	0,35	M17x1	10	M8x1	31/23		
	nml*	101658	26440R	M15x1	10	0,60	M17x1	10	M8x1	31/23		
	nml*	101612	26440R	M15x1	10	0,35	M17x1	10	M8x1	22/15		
	nml*	101614	26440R	M15x1	10	0,35	M17x1	10	M8x1	22/15		
	nml*	101640	26440R	M15x1	10	0,35	M17x1	10	M8x1	31/23		
	nml*	101618	26440R	M15x1	10	0,35	M17x1	10	M10x1	34/15		
	3	nml*	101643	26440R	M15x1	10	0,45	M17x1	10	M10x1	34/15	
		nml*	101664	26440R	M15x1	10	0,55	M17x1	10	M10x1	34/15	
		nml*	101644	26440R	M15x1	10	0,65	M17x1	10	M10x1	34/15	
nml*		101650	26440R	M15x1	10	0,35	M17x1	10	M8x1	31/23		
nml*		101651	26440R	M15x1	10	1,10	M17x1	10	M8x1	31/23		
nml*		101652	26440R	M15x1	10	1,25	M17x1	10	M8x1	31/23		
nml*		101681	26440R	M15x1	10	0,35	M17x1	10	M8x1	31/15		
4		nml*	101646**	26440RD	M15x1	10	0,35	M17x1	10	M8x1	31/23	

*nicht mehr lieferbar

**mit Drossel für Hauptgasleitung

EGA 26400 mit Düsenausgang, ohne Zündflammenanschluss

EGA 26440 mit Düsenausgang, mit Zündflammenanschluss



Abb.	Bestell-Nr.	Ersatz-Nr.	Typ EGA	Gaseingang	ø Rohreingang (mm)	ø Düsen (mm)			Mischrohranschluss	Thermoelementanschluss	L1/L2 (mm)	Achse (mm)
						Außendüse	Innendüse	Kleinbranddüse				
1	nml*	101604	26400D	M15x1	10	-	-	0,35	M17x1	M8x1	22/15	
	nml*	101607	26400D	M15x1	10	-	-	0,35	M17x1	M8x1	31/23	
	nml*	101617	26400D	M15x1	10	-	-	0,35	M17x1	M8x1	24/15	
2	nml*	101797	26400D	M15x1	8	-	-	0,35	M17x1	M8x1	24/15	
	nml*	101609	26400D	M15x1	10	2,20	0,60	0,35	M17x1	M8x1	24/15	
	nml*	101667	26400D	M15x1	8	2,20	0,60	0,35	M17x1	M8x1	24/15	
3	nml*	101675	26400D	M15x1	8	2,60	0,95	0,70	M17x1	M8x1	24/15	
	nml*	101619	26440D	M15x1	10	-	-	0,35	M17x1	M8x1	31/23	
	nml*	101613	26440D	M15x1	10	-	-	0,35	M17x1	M10x1	34/15	
4	nml*	101615	26440D	M15x1	10	-	-	0,35	M17x1	M8x1	31/15	
	nml*	101606	26440D	M15x1	10	-	-	0,35	M17x1	M8x1	31/23	
	nml*	101663	26440D	M15x1	10	2,05	1,85	0,35	M17x1	M8x1	31/23	
	nml*	101983	26440D	M15x1	10	1,35	0,66	0,35	M17x1	M10x1	34/15	
	nml*	101668	26440D	M15x1	10	1,35	1,20	0,35	M17x1	M10x1	34/15	
	nml*	101642	26440D	M15x1	10	1,55	0,80	0,45	M17x1	M10x1	34/15	
	nml*	101767	26440D	M15x1	10	1,55	1,40	0,45	M17x1	M10x1	34/15	
	nml*	101731	26440D	M15x1	10	2,05	1,05	0,55	M17x1	M10x1	34/15	
	nml*	101641	26440D	M15x1	10	2,05	1,90	0,55	M17x1	M10x1	34/15	
	nml*	101633	26440D	M15x1	10	1,40	0,80	0,35	M17x1	M8x1	31/23	
5	nml*	101634	26440D	M15x1	10	1,85	1,05	0,50	M17x1	M8x1	31/23	
	nml*	101647	26440DF	M15x1	10	-	-	0,35	M17x1	M8x1	31/23	
	nml*	101653	26440DF	M15x1	10	-	1,40	0,85	M17x1	M8x1	31/23	
	nml*	101654	26440DF	M15x1	10	-	1,80	1,10	M17x1	M8x1	31/23	
	nml*	101655	26440DF	M15x1	10	-	2,05	1,25	M17x1	M8x1	31/23	

*nicht mehr lieferbar

EGA 24197 mit Rohrausgang EGA 24197 mit Düsenausgang



Abb.	Bestell-Nr.	Ersatz-Nr.	Typ EGA	Gaseingang	ø Düsen (mm)			Gasausgang	Mischrohr-anschluss	Thermoelement-anschluss	L1/L2 (mm)	Achse (mm)
					Außendüse	Innendüse	Kleinbranddüse					
1	nml*	101620	24197R	-	-	0,35	-	-	M8x1	35/21		
	nml*	101621	24197R	-	-	0,35	-	-	M8x1	34/15		
	nml*	101636	24197R	-	-	0,35	M18x1,5 ø 12mm	-	M8x1	34/15		
	nml*	101666	24197R	-	-	0,35	-	-	M8x1	34/15		
	nml*	101657	24197RD	-	-	0,5	-	-	M8x1	35/21		
	nml*	101622	24197D	-	-	0,35	-	M22x1,5	M8x1	35/21		
	nml*	101624	24197D	-	-	0,35	-	M22x1,5	M8x1	34/15		
2	nml*	101625	24197D	M18x1,5 ø 12mm	-	0,35	-	M22x1,5	M8x1	34/15		
	nml*	101623	24197D	-	-	0,35	-	M22x1,5	M8x1	34/15		
	nml*	101649	24197D	2,60	1,35	0,40	-	M22x1,5	M8x1	34/15		
	nml*	101659	24197D	2,20	1,15	0,35	-	M22x1,5	M8x1	34/15		
	nml*	101656	24197D	4,40	2,50	1,65	-	M22x1,5	M8x1	35/21		
3	nml*	101662	24197D	2,10	1,00	0,35	-	M22x1,5	M8x1	34/15		
	nml*	101665	24197D	1,60	0,80	0,35	-	M22x1,5	M8x1	34/15		
	nml*	101764	24197D	1,60	1,00	0,35	-	M22x1,5	M8x1	34/15		
4	nml*	106040**	24197D	-	-	0,35	-	M22x1,5	M8x1	34/15		
	nml*	106041**	24197D	-	-	0,35	-	M22x1,5	M8x1	34/15		

*nicht mehr lieferbar

**Ausgang für Zündflamme geschlossen

Zubehör und Ersatzteile für EGA 26400/26440

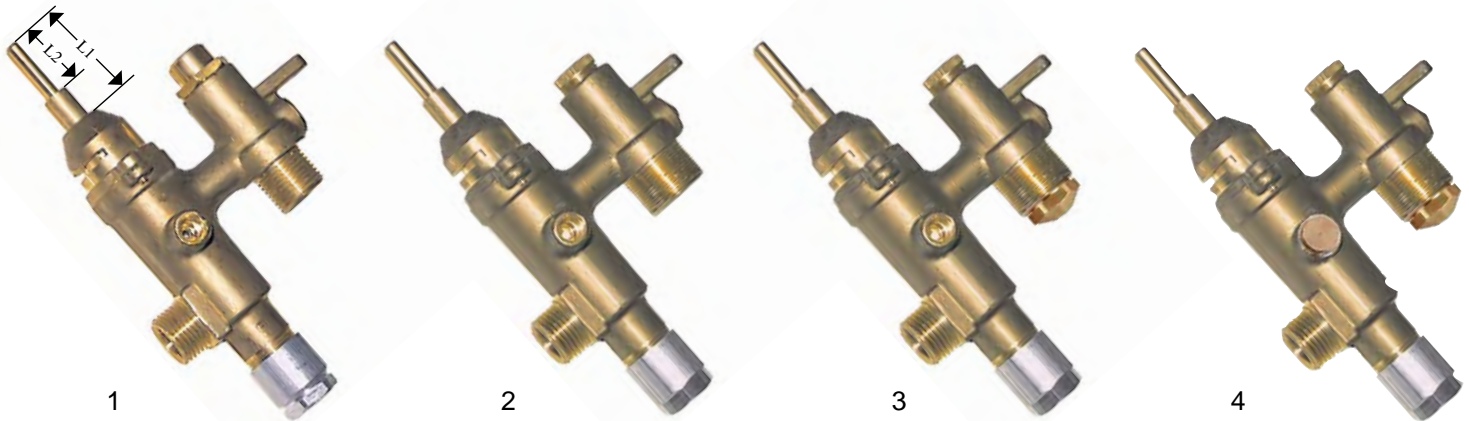
Kleinbranddüsen



Pos.	Bestell-Nr.	ø (mm)	Pos.	Bestell-Nr.	ø (mm)	Pos.	Bestell-Nr.	ø (mm)
1	nml*	0,23	9	100354	0,50	17	100346	0,85
2	nml*	0,30	10	100355	0,52	20	100347	0,90
3	nml*	0,33	11	100356	0,55	21	100362	1,00
4	100364	0,35	12	100368	0,60	22	100348	1,10
5	nml*	0,37	13	100361	0,65	23	100359	1,20
6	100353	0,40	14	100357	0,70	24	100363	1,50
7	100366	0,44	15	100358	0,75	25	106236	1,70
8	100367	0,47	16	100328	0,80	26	100349	1,80

*nicht mehr lieferbar



Abb.	Bestell-Nr.	Beschreibung	Gewinde	ø Rohr (mm)
	100941	Überwurfmutter	M15x1	8
1	100942	Überwurfmutter	M15x1	10
	100943	Überwurfmutter	M17x1	10
	101450	Doppelkonus	-	8
2	101278	Doppelkonus	-	10
3	101285	Überwurfschraube	M8x1	4
4	101284	Doppelkonus	-	4



Abb.	Bestell-Nr.	Beschreibung	Gewinde	Abb.	Bestell-Nr.	Beschreibung	Gewinde
1	100926	Zentrierring	M17x1	3	101230	Magnetmutter	M8x1
2	101394	Mutter	M17x1		101233	Magnetmutter	M10x1



Abb.	Bestell-Nr.	Beschreibung	Typ Gashahn	Abb.	Bestell-Nr.	Beschreibung	Typ Gashahn
1	101051	Magneteinsatz	31849 31248 30750	2	101060	Magneteinsatz	26400 26440

Außendüsen M12x1



Pos.	Bestell-Nr.	ø (mm)	Pos.	Bestell-Nr.	ø (mm)	Pos.	Bestell-Nr.	ø (mm)
1	100974	0,80	18	100287	1,45	35	100309	2,30
2	100279	0,82	19	100700	1,50	36	100668	2,35
3	100249	0,85	20	100301	1,55	37	100294	2,40
4	100283	0,90	21	100665	1,60	38	100749	2,45
5	100280	0,93	22	100239	1,65	39	100326	2,50
6	100282	0,95	23	100288	1,70	40	100416	2,55
7	100284	1,00	24	100878	1,75	41	100304	2,60
8	100662	1,05	25	100289	1,80	42	100295	2,70
9	100285	1,10	26	100302	1,85	43	100305	3,00
10	100243	1,12	27	100290	1,90	44	100752	3,20
11	100663	1,15	28	100740	1,95	45	100296	3,30
12	100306	1,20	29	100291	2,00	46	100297	3,45
13	100975	1,25	30	100303	2,05	47	100298	3,50
14	100286	1,30	31	100292	2,10	48	100299	3,70
15	100300	1,35	32	100744	2,12	49	100763	3,80
16	100669	1,37	33	100308	2,15	50	102794	3,85
17	100307	1,40	34	100293	2,20	51	100762	4,10

Innendüsen



Pos.	Bestell-Nr.	ø (mm)	Pos.	Bestell-Nr.	ø (mm)	Pos.	Bestell-Nr.	ø (mm)
1	100657	0,60	8	100315	0,95	15	100316	1,70
2	100310	0,66	9	100312	1,05	16	100951	1,75
3	100319	0,75	10	100313	1,20	17	100244	1,85
4	100393	0,78	11	100238	1,35	18	100314	1,90
5	100311	0,80	12	100322	1,40	19	100274	2,00
6	100624	0,85	13	100773	1,55	20	100317	2,20
7	100321	0,90	14	100318	1,60	21	100678	2,50

Innendüsen für Gashahn mit fester Außendüse



Pos.	Bestell-Nr.	ø (mm)	Pos.	Bestell-Nr.	ø (mm)	Pos.	Bestell-Nr.	ø (mm)
1	100395	1,40	2	100396	1,80	3	100397	2,05

Zubehör und Ersatzteile für EGA 24197

Kleinbranddüsen



Pos.	Bestell-Nr.	ø (mm)	Pos.	Bestell-Nr.	ø (mm)	Pos.	Bestell-Nr.	ø (mm)
1	nml*	0,23	9	100354	0,50	17	100346	0,85
2	nml*	0,30	10	100355	0,52	20	100347	0,90
3	nml*	0,33	11	100356	0,55	21	100362	1,00
4	100364	0,35	12	100368	0,60	22	100348	1,10
5	nml*	0,37	13	100361	0,65	23	100359	1,20
6	100353	0,40	14	100357	0,70	24	100363	1,50
7	100366	0,44	15	100358	0,75	25	106236	1,70
8	100367	0,47	16	100328	0,80	26	100349	1,80

*nicht mehr lieferbar



Abb.	Bestell-Nr.	Beschreibung	Gewinde	ø Rohr (mm)
1	100944	Überwurfmutter	M18x1,5	12
2	101273	Doppelkonus	-	12
3	101285	Überwurfschraube	M8x1	4
4	101284	Klemmring	-	4



Abb.	Bestell-Nr.	Beschreibung	Gewinde
1	101230	Magnetmutter	M8x1
	101233	Magnetmutter	M10x1
2	101058	Magneteinsatz	

Außendüsen M15x1



Pos.	Bestell-Nr.	ø (mm)	Pos.	Bestell-Nr.	ø (mm)	Pos.	Bestell-Nr.	ø (mm)
1	100451	1,50	7	100456	2,50	13	100406	3,70
2	100337	1,60	8	100457	2,60	14	100332	3,80
3	100453	2,00	9	100331	2,70	15	100335	3,90
4	100338	2,10	10	100698	3,00	16	100336	4,00
5	100330	2,20	11	100339	3,40	17	100329	4,40
6	100333	2,30	12	100334	3,50			

Innendüsen



Pos.	Bestell-Nr.	ø (mm)	Pos.	Bestell-Nr.	ø (mm)	Pos.	Bestell-Nr.	ø (mm)
1	100377	0,65	8	100341	1,15	14	100658	1,80
2	100496	0,73	9	100344	1,20	15	100323	1,85
3	100378	0,77	10	100647	1,30	16	100345	1,90
4	100492	0,80	11	100648	1,35	17	100324	2,10
5	100340	0,85	12	100342	1,40	18	100327	2,35
6	100343	1,00	13	100656	1,60	19	100398	2,50
7	100495	1,05						

Gashähne EGA/PEL20/21

PEL20 mit Rohrausgang, ohne Zündflammenanschluss

PEL21 mit Rohrausgang, mit Zündflammenanschluss



Abb.	Bestell-Nr.	Typ	Gaseingang	ø Rohr (mm)	ø Kleinbranddüse (mm)	Gasausgang	ø Rohrausgang (mm)	Thermoelementanschluss	L1/L2 (mm)	Achse (mm)
	101608	PEL20R	M15x1	10	0,35	M17x1	10	M8x1	34/15	
1	101616	PEL20R	M15x1	10	0,35	M17x1	10	M8x1	31/15	
	101603	PEL20R	M15x1	10	0,35	M17x1	10	M8x1	31/23	
2	101648*	PEL20RD	M15x1	10	0,35	M17x1	10	M8x1	31/23	
	101605	PEL21R	M15x1	10	0,35	M17x1	10	M8x1	31/23	
	101658	PEL21R	M15x1	10	0,60	M17x1	10	M8x1	31/23	
	101612	PEL21R	M15x1	10	0,35	M17x1	10	M8x1	22/15	
	101614	PEL21R	M15x1	10	0,35	M17x1	10	M8x1	22/15	
	101618	PEL21R	M15x1	10	0,35	M17x1	10	M10x1		
	101643	PEL21R	M15x1	10	0,45	M17x1	10	M10x1	34/15	
3	101664	PEL21R	M15x1	10	0,55	M17x1	10	M10x1	34/15	
	101644	PEL21R	M15x1	10	0,65	M17x1	10	M10x1	34/15	
	101640	PEL21R	M15x1	10	0,35	M17x1	10	M8x1	31/23	
	101650	PEL21R	M15x1	10	0,35	M17x1	10	M8x1	31/23	
	101651	PEL21R	M15x1	10	1,10	M17x1	10	M8x1	31/23	
	101652	PEL21R	M15x1	10	1,25	M17x1	10	M8x1	31/23	
	101681	PEL21R	M15x1	10	0,35	M17x1	10	M8x1	31/15	
4	101646*	PEL21RD	M15x1	10	0,35	M17x1	10	M8x1	31/23	

*mit Drossel für Hauptgasleitung

PEL20 mit Düsenausgang, ohne Zündflammenanschluss

PEL21 mit Düsenausgang, mit Zündflammenanschluss

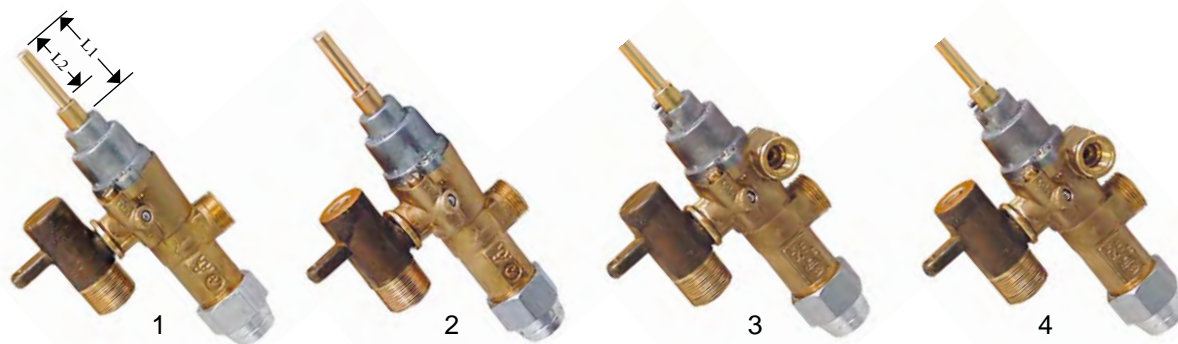

Abb.	Bestell-Nr.	Typ	Gaseingang	ø Rohr (mm)	ø Düsen (mm)			Mischrohranschluss	Thermoelementanschluss	L1/L2 (mm)	Achse (mm)
					Außendüse	Innendüse	Kleinbranddüse				
1	101604	PEL20D	M15x1	10	-	-	0,35	M17x1	M8x1	22/15	
	101607	PEL20D	M15x1	10	-	-	0,35	M17x1	M8x1	31/23	
	101617	PEL20D	M15x1	10	-	-	0,35	M17x1	M8x1	24/15	
	101797	PEL20D	M15x1	8	-	-	0,35	M17x1	M8x1	24/15	
2	101609	PEL20D	M15x1	10	2,20	0,60	0,35	M17x1	M8x1	24/15	
	101667	PEL20D	M15x1	8	2,20	0,60	0,35	M17x1	M8x1	24/15	
	101675	PEL20D	M15x1	8	2,60	0,95	0,70	M17x1	M8x1	24/15	
3	101606	PEL21D	M15x1	10	-	-	0,35	M17x1	M8x1	31/23	
	101619	PEL21D	M15x1	10	-	-	0,35	M17x1	M8x1	31/23	
	101613	PEL21D	M15x1	10	-	-	0,35	M17x1	M10x1	34/15	
	101615	PEL21D	M15x1	10	-	-	0,35	M17x1	M8x1	31/15	
4	101633	PEL21D	M15x1	10	1,40	0,80	0,35	M17x1	M8x1	31/23	
	101634	PEL21D	M15x1	10	1,85	1,05	0,50	M17x1	M8x1	31/23	
	101983	PEL21D	M15x1	10	1,35	0,66	0,35	M17x1	M10x1	34/15	
	101668	PEL21D	M15x1	10	1,35	1,20	0,35	M17x1	M10x1	34/15	
	101642	PEL21D	M15x1	10	1,55	0,80	0,45	M17x1	M10x1	34/15	
	101767	PEL21D	M15x1	10	1,55	1,40	0,45	M17x1	M10x1	34/15	
	101731	PEL21D	M15x1	10	2,05	1,05	0,55	M17x1	M10x1	34/15	
	101641	PEL21D	M15x1	10	2,05	1,90	0,55	M17x1	M10x1	34/15	
5	101663	PEL21D	M15x1	10	2,05	1,85	0,35	M17x1	M8x1	31/23	
	101647	PEL21DF	M15x1	10	-	-	0,35	M17x1	M8x1	31/23	
	101653	PEL21DF	M15x1	10	-	1,40	0,85	M17x1	M8x1	31/23	
	101654	PEL21DF	M15x1	10	-	1,80	1,10	M17x1	M8x1	31/23	
	101655	PEL21DF	M15x1	10	-	2,05	1,25	M17x1	M8x1	31/23	

Gashähne EGA/PEL22



1

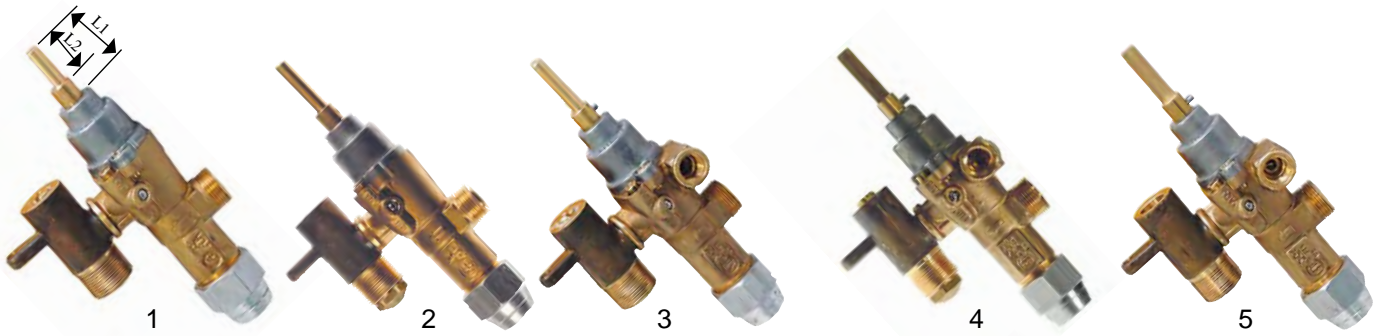
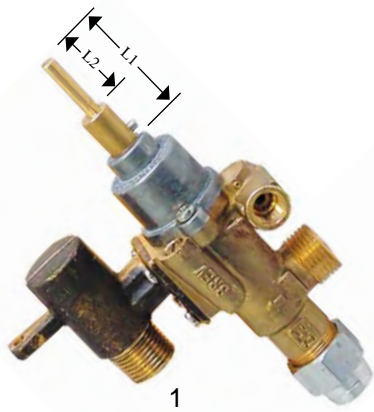
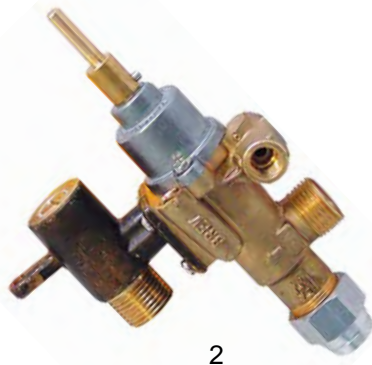

2

Abb.	Bestell-Nr.	Typ	Gaseingang	ø Rohreingang (mm)	ø Kleinbranddüse (mm)	Gasausgang	ø Rohrausgang (mm)	Thermoelementanschluss	L1/L2 (mm)	Achse (mm)
	101621	PEL22R	M18x1,5	12	0,35	M18x1,5	12	M8x1	34/15	
	101636	PEL22R	M18x1,5	12	0,35	M18x1,5	12	M8x1	34/15	
1	101666	PEL22R	M18x1,5	12	0,35	M18x1,5	12	M8x1	34/15	
	101620	PEL22R	M18x1,5	12	0,35	M18x1,5	12	M8x1	35/21	
2	101657	PEL22RD	M18x1,5	12	0,5	M18x1,5	12	M8x1	35/21	



1



2



3

Abb.	Bestell-Nr.	Typ	Gaseingang	ø Rohreingang (mm)	ø Düsen (mm)			Mischrohranschluss	Thermoelementanschluss	L1/L2 (mm)	Achse (mm)
					Außendüse	Innendüse	Kleinbranddüse				
1	106040*	PEL22D	M18x1,5	12	-	-	0,35	M22x1,5	M8x1	34/15	
	106041*	PEL22D	M18x1,5	12	-	-	0,35	M22x1,5	M8x1	34/15	
	101625	PEL22D	M18x1,5	12	-	-	0,35	M22x1,5	M8x1	34/15	
2	101622	PEL22D	M18x1,5	12	-	-	0,35	M22x1,5	M8x1	35/21	
	101624	PEL22D	M18x1,5	12	-	-	0,35	M22x1,5	M8x1	34/15	
	101623	PEL22D	M18x1,5	12	-	-	0,35	M22x1,5	M8x1	34/15	
	101649	PEL22D	M18x1,5	12	2,60	1,35	0,40	M22x1,5	M8x1	34/15	
	101659	PEL22D	M18x1,5	12	2,20	1,15	0,35	M22x1,5	M8x1	34/15	
3	101656	PEL22D	M18x1,5	12	4,40	2,50	1,65	M22x1,5	M8x1	35/21	
	101662	PEL22D	M18x1,5	12	2,10	1,00	0,35	M22x1,5	M8x1	34/15	
	101665	PEL22D	M18x1,5	12	1,60	0,80	0,35	M22x1,5	M8x1	34/15	
	101764	PEL22D	M18x1,5	12	1,60	1,00	0,35	M22x1,5	M8x1	34/15	

*Zündleitungsausgang verschlossen

Zubehör und Ersatzteile für EGA/PEL20/21



Abb.	Bestell-Nr.	Beschreibung	Gewinde	ø Rohr (mm)
	100941	Überwurfmutter	M15x1	8
1	100942	Überwurfmutter	M15x1	10
	100943	Überwurfmutter	M17x1	10
	101450	Doppelkonus	-	8
2	101278	Doppelkonus	-	10
3	100926	Zentrierung	M17x1	
4	101394	Mutter	M17x1	
	100908	Schraube	M10x1	4
5	100909	Schraube	M10x1	6
6	101246	Doppelkonus	-	4
7	101286	Doppelkonus	-	6



Abb.	Bestell-Nr.	Beschreibung	für Thermoelement
	101230	Magnetmutter	M8x1
1	101231	Magnetmutter	M9x1
	101290	Magnetmutter	M10x1
2	101060	Magneteinsatz	-

Vorderteile

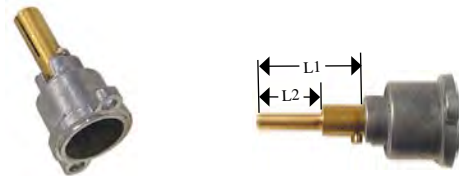

Pos.	Bestell-Nr.	Typ	L1/L2 (mm)	Achse (mm)
	106167	PEL20	22/15	
1	101805	PEL21	22/15	
	101801	PEL20	31/23	
	101803	PEL21	31/23	
2	101809	PEL20	24/15	
	101810	PEL20	34/15	
3	101806	PEL21	34/15	
4	101802	PEL21	31/23	
	101206	PEL21	22/15	
5	101807	PEL21	31/23	
	101808	PEL21	31/15	
6	101811	PEL20	31/15	

Kleinbranddüsen PEL20/21



Pos.	Bestell-Nr.	ø (mm)	Pos.	Bestell-Nr.	ø (mm)	Pos.	Bestell-Nr.	ø (mm)
1	100408	0,35	10	100555	0,80	18	100532	1,20
2	100553	0,40	11	100527	0,85	19	100394	1,25
3	100554	0,45	12	100528	0,90	20	100533	1,30
4	100526	0,50	13	100556	0,95	21	100549	1,35
5	100550	0,55	14	100529	1,00	22	100534	1,40
6	100551	0,60	15	100557	1,05	23	100558	1,55
7	100548	0,65	16	100530	1,10	24	100559	1,70
8	100552	0,70	17	100531	1,15	25	100547	1,75
9	100278	0,75						

Außendüsen M12x1



Pos.	Bestell-Nr.	ø (mm)	Pos.	Bestell-Nr.	ø (mm)	Pos.	Bestell-Nr.	ø (mm)
1	100974	0,80	18	100287	1,45	35	100309	2,30
2	100279	0,82	19	100700	1,50	36	100668	2,35
3	100249	0,85	20	100301	1,55	37	100294	2,40
4	100283	0,90	21	100665	1,60	38	100749	2,45
5	100280	0,93	22	100239	1,65	39	100326	2,50
6	100282	0,95	23	100288	1,70	40	100416	2,55
7	100284	1,00	24	100878	1,75	41	100304	2,60
8	100662	1,05	25	100289	1,80	42	100295	2,70
9	100285	1,10	26	100302	1,85	43	100305	3,00
10	100243	1,12	27	100290	1,90	44	100752	3,20
11	100663	1,15	28	100740	1,95	45	100296	3,30
12	100306	1,20	29	100291	2,00	46	100297	3,45
13	100975	1,25	30	100303	2,05	47	100298	3,50
14	100286	1,30	31	100292	2,10	48	100299	3,70
15	100300	1,35	32	100744	2,12	49	100763	3,80
16	100669	1,37	33	100308	2,15	50	102794	3,85
17	100307	1,40	34	100293	2,20	51	100762	4,10

Innendüsen



Pos.	Bestell-Nr.	ø (mm)	Pos.	Bestell-Nr.	ø (mm)	Pos.	Bestell-Nr.	ø (mm)
1	100657	0,60	8	100315	0,95	15	100316	1,70
2	100310	0,66	9	100312	1,05	16	100951	1,75
3	100319	0,75	10	100313	1,20	17	100244	1,85
4	100393	0,78	11	100238	1,35	18	100314	1,90
5	100311	0,80	12	100322	1,40	19	100274	2,00
6	100624	0,85	13	100773	1,55	20	100317	2,20
7	100321	0,90	14	100318	1,60	21	100678	2,50

Innendüsen für Gashahn mit fester Außendüse



Pos.	Bestell-Nr.	ø (mm)	Pos.	Bestell-Nr.	ø (mm)	Pos.	Bestell-Nr.	ø (mm)
1	100395	1,40	2	100396	1,80	3	100397	2,05

Zubehör und Ersatzteile für EGA/PEL22









Abb.	Bestell-Nr.	Beschreibung	Gewinde	ø Rohr (mm)
1	100944	Überwurfmutter	M18x1,5	12
2	101273	Doppelkonus	-	12
3	100908	Schraube	M10x1	4
4	100909	Schraube	M10x1	6
5	101246	Klemmring	-	4
6	101286	Klemmring	-	6

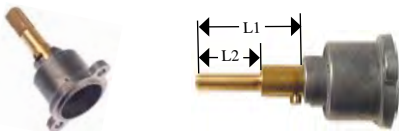

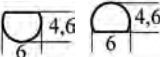
Abb.	Bestell-Nr.	Beschreibung	für Thermoelement
	101230	Magnetmutter	M8x1
1	101231	Magnetmutter	M9x1
	101290	Magnetmutter	M10x1
2	101058	Magneteinsatz	-

Vorderteile



Pos.	Bestell-Nr.	L1/L2 (mm)	Achse (mm)
1	101823	35/21	
2	101820	34/15	
3	101821	34/15	
4	106170	34/15	
5	101822	34/15	
6	106171	34/15	

Gashähne JUNKERS





Abb.	Bestell-Nr.	Ersatz-Nr.	Beschreibung	Gaseingang	Gasausgang	Thermoelementanschluss	L (mm)	Achse (mm)
1	nml*	101457	CH110	M20x1,5	M20x1,5	M8x1	20,7	
2	nml*	101457	CH120	M20x1,5	M20x1,5	M8x1	20,7	
	nml*	101798	CH140	3/8"	3/8"	M8x1	20,7	
3	nml*	101630	CH330	1/2" I	1/2" A	M10x1	20,7	

*nicht mehr lieferbar

Kleinbranddüsen

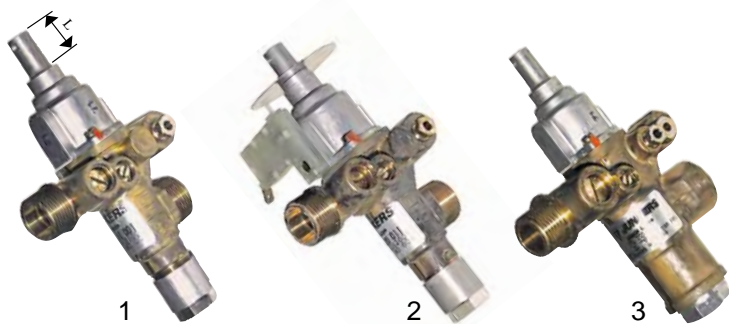

Pos.	Bestell-Nr.	ø (mm)	Pos.	Bestell-Nr.	ø (mm)	Pos.	Bestell-Nr.	ø (mm)
1	100259	0,35	8	100429	0,70	15	100435	1,05
2	100281	0,40	9	100432	0,75	16	100436	1,10
3	100414	0,45	10	100409	0,80	17	100437	1,15
4	100390	0,50	11	100410	0,85	18	100438	1,20
5	100391	0,55	12	100433	0,90	19	100413	1,65
6	100392	0,60	13	100434	0,95	20	100776	1,75
7	100428	0,65	14	100407	1,00			

Außendüsen



Pos.	Bestell-Nr.	ø (mm)	Pos.	Bestell-Nr.	ø (mm)	Pos.	Bestell-Nr.	ø (mm)
1	100451	1,50	7	100456	2,50	13	100406	3,70
2	100337	1,60	8	100457	2,60	14	100332	3,80
3	100453	2,00	9	100331	2,70	15	100335	3,90
4	100338	2,10	10	100698	3,00	16	100336	4,00
5	100330	2,20	11	100339	3,40	17	100329	4,40
6	100333	2,30	12	100334	3,50			

Innendüsen



Pos.	Bestell-Nr.	ø (mm)	Pos.	Bestell-Nr.	ø (mm)	Pos.	Bestell-Nr.	ø (mm)
1	100377	0,65	8	100341	1,15	14	100658	1,80
2	100496	0,73	9	100344	1,20	15	100323	1,85
3	100378	0,77	10	100647	1,30	16	100345	1,90
4	100492	0,80	11	100648	1,35	17	100324	2,10
5	100340	0,85	12	100342	1,40	18	100327	2,35
6	100343	1,00	13	100656	1,60	19	100398	2,50
7	100495	1,05						



Abb.	Bestell-Nr.	Ersatz-Nr.	Beschreibung	Gaseingang	Gasausgang	Thermoelementanschluss	L (mm)	Achse (mm)
1	nml*	101630	CH340	1/2" IG	1/2" AG	M10x1	20,7	
2	nml*	-	CH430	3/4" IG	3/4" AG	M10x1	20,7	
3	nml*	-	CH440	3/4" IG	3/4" AG	M10x1	20,7	

*nicht mehr lieferbar

Gashähne PEL als Ersatz für JUNKERS

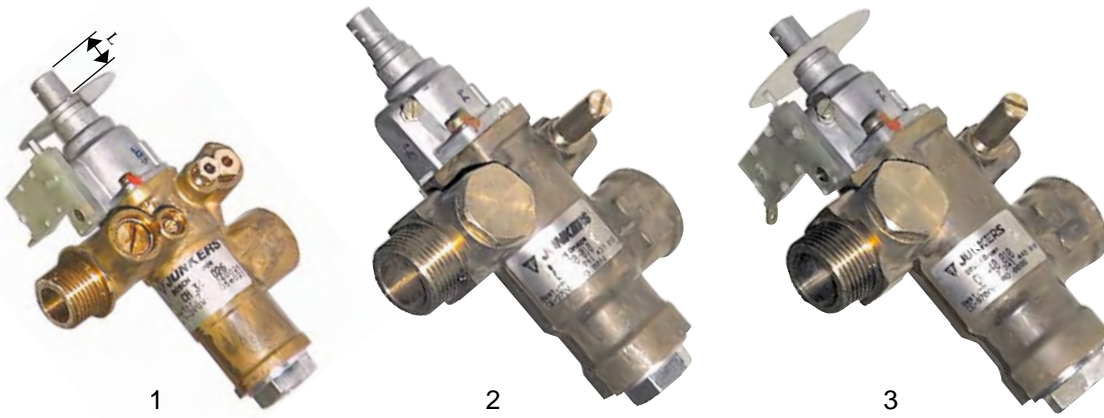

Abb.	Bestell-Nr.	Beschreibung	Gaseingang	∅ Rohreingang (mm)	∅ Kleinbranddüse (mm)	Gasausgang	∅ Rohrausgang (mm)	Thermoelementanschluss	L (mm)	Achse (mm)
1	101457	PEL22S/V	M20x1,5	12	0,35	M20x1,5	12/10	M8x1	25	
2	101798	PEL22S/V	3/8"	-	0,35	3/8"	-	M10x1	25	
3	101630	PEL23S/V	1/2" IG	-	0,35	1/2" AG	-	M10x1	25	

Zubehör und Ersatzteile für Gashähne JUNKERS

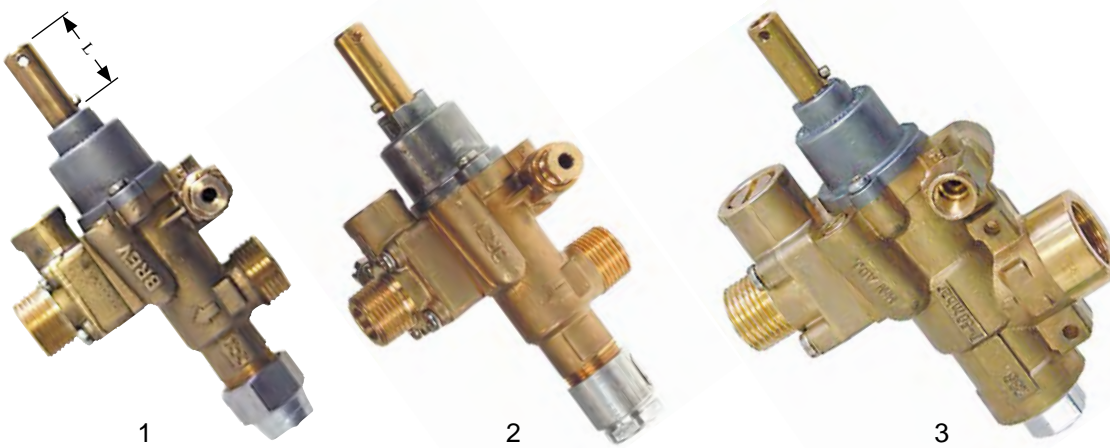

Abb.	Bestell-Nr.	Beschreibung	für Typ Gashahn
1	101232	Thermoelementmutter M8x1	
	101233	Thermoelementmutter M10x1	CH1_
2	101060	Magneteinsatz	
3	101061	Magneteinsatz	CH3_
4	101062	Magneteinsatz	CH4_

Abb.	Bestell-Nr.	Beschreibung	für Typ Gashahn
1	101218	Achsverlängerung ∅ 8mm	
2	101219	Achsverlängerung 6x4,6mm	CH1_ CH3_ CH4_
3	550396	Achsverlängerung 6x4,6mm	
4	100945	Splint 3,2x10mm	
5	101285	Überwurfschraube M8x1, ∅ 4mm	CH1_ , CH3_ , CH4_
6	101284	Doppelkonus ∅ 4mm	
7	345200	Mikroschalter	CH120/140 CH340/440

Gashähne STN3R







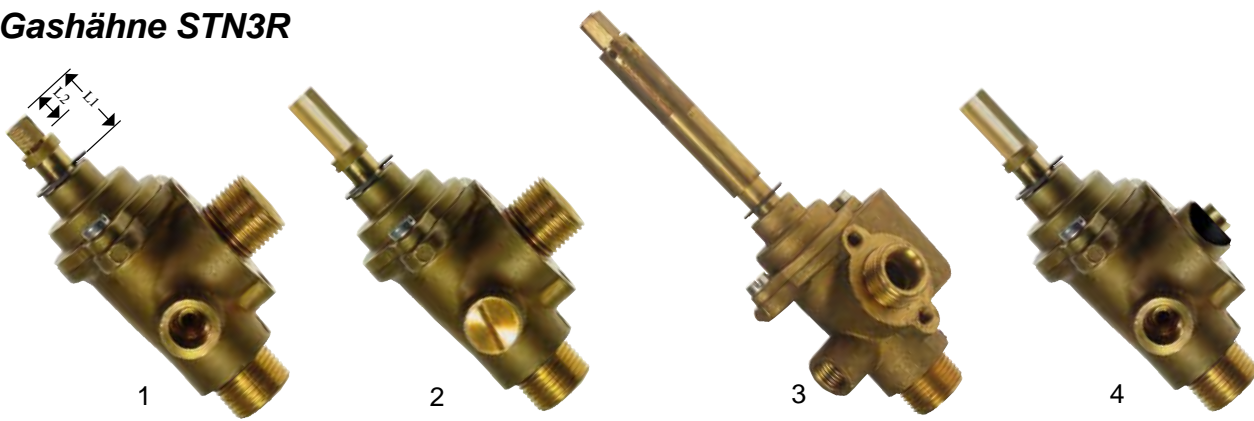

Abb.	Bestell-Nr.	Gaseingang	ø Rohr (mm)	ø Kleinbranddüse (mm)	Pilotanschluss	Gasausgang	ø Rohrausgang (mm)	L1/L2 (mm)	passend für	Achse (mm)
1	106176	3/8"	8	-	M10x1	3/8"	8	17/7	Morice	
	106177	3/8"	8	-	M10x1	3/8"	8	28/-		
	106188	3/8"	8	-	M10x1	3/8"	8	34/-		
2	106178	3/8"	8	-	M10x1 geschlossen	3/8"	8	28/-	Solymac	
	106179	3/8"	8	-	M10x1 geschlossen	3/8"	8	60/-	Solymac	
3	106141	3/8"	8	-	M10x1	3/8"	8	67/9	Bonnet	
4	106180	Rohrflansch ø 21mm	-	-	M10x1	M18x1,5	-	38/-		
	106182	Rohrflansch	-	-	M10x1	3/8"	8	27/-	Cometto	
	106181	Rohrflansch	-	-	M10x1	3/8"	8	25/-	Solymac	

G

Gashähne







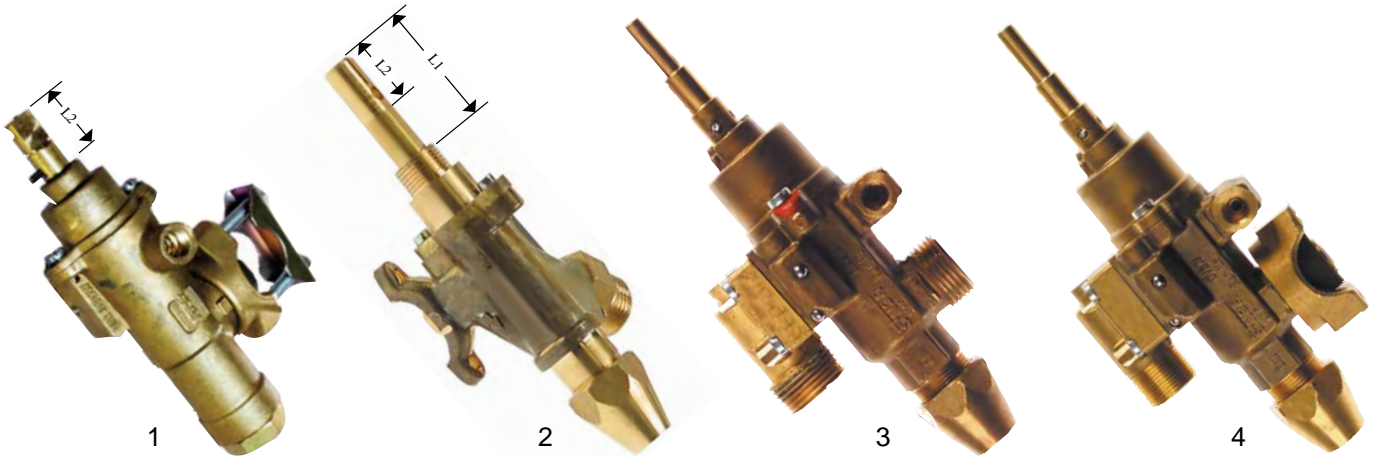

Abb.	Bestell-Nr.	Gaseingang	ø Rohr (mm)	ø Kleinbranddüse (mm)	Gasausgang	ø Rohrausgang (mm)	Thermoelementanschluss	L1/L2 (mm)	passend für	Achse (mm)
1	106183	Rohrflansch ø 21mm	-	-	3/8" AG	-	M9x1	20/-		
	106184	Rohrflansch ø 21mm	-	-	3/8" IG	10	M9x1	22/-		
	106185	Rohrflansch ø 21mm	-	-	3/8" IG	10	M9x1	23/-	Charvet	
	106186	Rohrflansch ø 21mm	-	-	3/8" IG	10	M9x1	20/-	Charvet	
2	101962	Rohrflansch	-	0	M16x1,25	Bördel	M8x1	28/14	Tecno MCM	
3	101988	M20x1,5	12	0	M20x1,5	12	M9x1	22/16	Tecno MCM	
	106052	M20x1,5	12	0	M20x1,5	12	M8x1	39/18	Küppersbusch	
4	106053	Rohrflansch	-	-	3/8"	10	M8x1	39/18	Küppersbusch	

Gashähne COPRECI



1



2



3

Abb.	Bestell-Nr.	Typ	Gaseingang	ø Rohreingang (mm)	ø Kleinbranddüse	Gasausgang	ø Rohrausgang (mm)	Thermoelementanschluss	L1/L2 (mm)	Achse (mm)
1	106036	CAL-5200	Rohrflansch	-	0,35	M14x1,5	6	M8x1	24/16	
2	109506	L-3200	M18x1,5	12	0,90	M18x1,5	12	-	30/12	
	109503	CAL-3200	M18x1,5	12	0,55	M18x1,5	12	M8x1	30/12	
	109509	CAL-3200	M18x1,5	12	0,80	M18x1,5	12	M8x1	30/12	
	109504	CAL-3200	M18x1,5	12	0,90	M18x1,5	12	M8x1	30/12	
3	109508	CAL-3200	M18x1,5	12	1,20	M18x1,5	12	M8x1	30/12	
	109505	CAL-3200	M18x1,5	12	1,30	M18x1,5	12	M8x1	30/12	
	109500	CAL-3200	M18x1,5	12	0,55	M18x1,5	12	M8x1	46/12	
	109501	CAL-3200	M18x1,5	12	0,90	M18x1,5	12	M8x1	46/12	
	109502	CAL-3200	M18x1,5	12	1,20	M18x1,5	12	M8x1	46/12	

Zubehör und Ersatzteile für STN3R



Abb.	Bestell-Nr.	Beschreibung	Gewinde	ø Rohr (mm)
1	101251	Überwurfmutter	M20x1,5	12
2	101273	Doppelkonus	-	12
3	101284	Doppelkonus	-	4
4	101964	Klemme	-	-
5	101051	Magneteinsatz	-	-
6	101058	Magneteinsatz	-	-





Zubehör und Ersatzteile für COPRECI



Abb.	Bestell-Nr.	Beschreibung	Gewinde	ø Rohr (mm)
1	100944	Überwurfmutter	M18x1,5	12
2	101273	Doppelkonus	-	12
3	101060	Magneteinsatz	CAL-5200	-
4	106173	Magneteinsatz	CAL-3200	-

Gashähne SABAF



Abb.	Bestell-Nr.	Typ	ø Gaseingang (mm)	ø Kleinbranddüse (mm)	Gasausgang	ø Rohrausgang (mm)	Frontbefestigung	Thermoelementanschluss	L1/L2 (mm)	Achse (mm)
1	101747	Sabaf 10	14	0,40	1/4"	8	M13x1	M8x1	23/17	
	101748	Sabaf 10	14	0,50	1/4"	8	M13x1	M8x1	23/17	
	101749	Sabaf 10	14	0,74	1/4"	8	-	M8x1	23/17	
2	101396	Sabaf 10	16	0	1/4"	8	-	M8x1	26/12	
	101357	Sabaf 10	16	0,52	1/4"	8	-	Steckanschluss	26/12	
3	101890	Sabaf 10	16	0	1/4"	8	-	Steckanschluss	26/12	
4	101994	Sabaf 10	16	0,65	1/4"	8	-	ø 2mm	26/12	





G
Gashähne

Abb.	Bestell-Nr.	Typ	ø Gaseingang	ø Rohr (mm)	ø Kleinbranddüse (mm)	Gasausgang	ø Rohrausgang (mm)	Thermoelementanschluss	L1/L2 (mm)	Achse (mm)
1	106025	Sabaf 10	ø 18mm	-	0,27	M13x1 IG	8	M8x1	35/15	
2	106062	Sabaf 10	ø 16mm	-	0,25	M13x1 IG	8	Steckanschluss	45/11	
3	101458	Sabaf 11	1/4"	8	0	1/4"	8	Steckanschluss	40/15	

Zubehör und Ersatzteile für SABAF

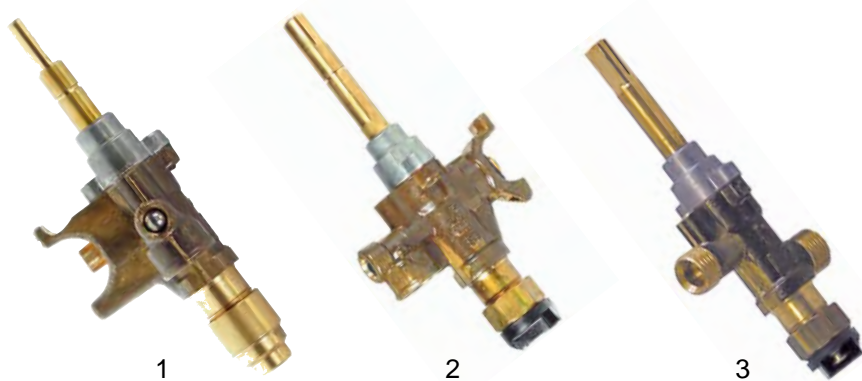

Abb.	Bestell-Nr.	Beschreibung	Gewinde	ø Rohr (mm)
1	520656	Überwurfmutter	1/4"	8
2	101477	Überwurfschraube	M13x1	8
3	101277	Doppelkonus	-	8



Abb.	Bestell-Nr.	Beschreibung
1	101051	Magneteinsatz
2	101751	Halter für Rohrflansch
3	101376	Dichtung für Rohrflansch

Diverse Gashähne







1



2



3

Abb.	Bestell-Nr.	Hersteller	Gaseingang	ø Kleinbranddüse (mm)	Gasausgang	ø Rohrausgang (mm)	Thermoelementanschluss	L1/L2 (mm)	Achse (mm)	Zubehör (Seite 30)
1	101697	Siral	Rohrflansch	0,42	1/4" AG	8	M8x1	23/12		Typen A,C
1	101698	Siral	Rohrflansch	0,45	1/4" AG	8	M8x1	23/12		Typen A,C
1	101699	Siral	Rohrflansch	0,85	1/4" AG	8	M8x1	23/12		Typen A,C
2	106013	ECA	Rohrflansch	-	1/4" AG	8	M8x1	20/13		Typen A,C
3	106015	Imit	Rohrflansch	0,45		12 (M6x0,75)	M8x1	22/15		Typen A,C



1



2



3

Abb.	Bestell-Nr.	Hersteller	Gaseingang	ø Kleinbranddüse (mm)	Gasausgang	ø Rohrausgang (mm)	Thermoelementanschluss	L1/L2 (mm)	Achse (mm)	Zubehör (Seite 30)
1	101891	SKG	Rohrflansch	0,45	gebördelt		M8x1	27/12		Typen B,C
2	101829	SKG	Rohrflansch	0,32/0,57	M13x1 IG	8	M8x1	30/13		Typen A,E,F
3	101825	SKG	Rohrflansch	0,40	M13x1 IG	8	M8x1	30/13		Typen A,D,F





Abb.	Bestell-Nr.	Anwendung	Hersteller	Gaseingang	Gasausgang	Thermoelementanschluss	L1/L2 (mm)	Achse (mm)
1	101420	Kochstelle	MAW	M22x1,5	M22x1,5	M10x1	35/25	
2	101423	Backofen ohne Kleinstellung	MAW	M22x1,5	M22x1,5	M10x1	35/25	

Zubehör und Ersatzteile für diverse Gashähne

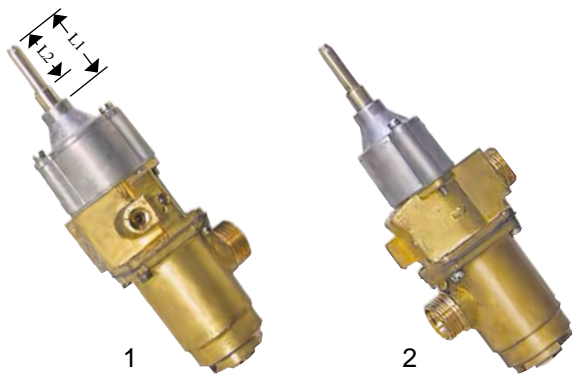

Abb.	Bestell-Nr.	Beschreibung	Gewinde	ø Rohr (mm)
1	520656	Überwurfmutter	1/4"	8
2	101477	Überwurfschraube	M13x1	8
3	101277	Doppelkonus	-	8



Abb.	Bestell-Nr.	Beschreibung	Typ (passend zu Gashähnen Seite 29)
1	101828	Halter für Rohrflansch	D
2	101832	Halter für Rohrflansch	E
3	101827	Dichtung	F
4	101826	Mikroschalter	F
5	101038	Zündschalter	F



Abb.	Bestell-Nr.	Beschreibung	Typ (passend zu Gashähnen Seite 29)
1	101051	Magneteinsatz	A
2	101060	Magneteinsatz	B
3	101351	Halter für Rohrflansch	C
4	101376	Dichtung	B

G

Gashähne