

Gasthermostate PEL 25/24



Seite 4

Gasthermostate SABAF



Seite 6

Gasthermostate COPRECI/IMIT

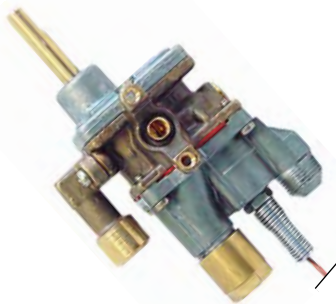

Seite 7

Gasthermostate ROBERTSHAW



Seite 8

Gasthermostate EGA



Seite 10

Gasthermostate SIT



Seite 11

Gasthermostate MP JUNKERS



Seite 16

Gasthermostate PEL 25S



Abb.	Bestell-Nr.	Temperatur (°C)	Gaseingang	ø Rohreingang (mm)	ø Kleinbranddüse (mm)	Gasausgang	ø Rohrausgang (mm)	Thermoelementanschluss	Kapillarlänge (mm)	ø Fühler (mm)	Länge Fühler (mm)	L1/L2 (mm)	Achse (mm)
1	101441	30 - 90	M16x1,5	10	0,35	M16x1,5	10/8	M9x1	1200	6	160	21/15	
	101955	bis 140	M16x1,5	10	0,50	M16x1,5	10/8	M8x1	1200	6	120	38/15	
	101442	100 - 200	M16x1,5	10	0,35	M16x1,5	10/8	M9x1	1200	6	120	21/15	
	101906	bis 250	M16x1,5	10	1,00	M16x1,5	10/8	M8x1	1200	6	120	36/20	
	101907	bis 280	M16x1,5	10	1,00	M16x1,5	10/8	M8x1	1200	6	120	36/20	
	101991	100 - 300	M16x1,5	10	0	M16x1,5	10/8	M9x1	1200	6	100	21/15	
	101172	100 - 300	M16x1,5	10	0,35	M16x1,5	10/8	M9x1	1200	6	100	21/15	
101332	120 - 320	M16x1,5	10	0	M16x1,5	10/8	M9x1	1200	6	100	21/15		
3	101901	50 - 300	Rohrflansch	-	0,35	M16x1,5	10/8	M9x1	1200	6	100	21/15	
	101905	100 - 200	ø 21mm	-	0,35	M16x1,5	10/8	M9x1	1200	6	120	21/15	

Gasthermostate PEL 24S



Abb.	Bestell-Nr.	Temperatur (°C)	Gaseingang	ø Rohreingang (mm)	ø Kleinbranddüse (mm)	Gasausgang	ø Rohrausgang (mm)	Thermoelementanschluss	Kapillarlänge (mm)	ø Fühler (mm)	Länge Fühler (mm)	L1/L2 (mm)	Achse (mm)	
1	101078	55 - 110	M20x1,5	12	0,35	M20x1,5	12/10	M9x1	1200	6	160	27/17		
	101077	110 - 220	M20x1,5	12	0,35	M20x1,5	12/10	M9x1	1200	6	120	27/17		
	101900	bis 280	M20x1,5	12	0,80	M20x1,5	12/10	M8x1	1200	6	120	31/15		
	106203	120 - 280	M20x1,5	12	0,35	M20x1,5	12/10	M9x1	1200	6	120	27/17		
	101759	100 - 300	M20x1,5	12	1,50	M20x1,5	12/10	M9x1	1200	6	100	27/17		
	101433	100 - 300	M20x1,5	12	0	M20x1,5	12/10	M9x1	1200	6	100	27/17		
	101076	120 - 320	M20x1,5	12	0,35	M20x1,5	12/10	M9x1	1200	6	100	27/17		
	106192	140 - 340	M20x1,5	12	0,35	M20x1,5	12/10	M8x1	1200	6	100	27/17		
	2	106193	bis 90	Flansch	-	0	M20x1,5	12/10	M9x1	1200	6	160	27/17	
		106194	bis 110			0			M9x1	1200	6	160	27/17	
106195		bis 210	0			M9x1			1200	6	120	27/17		
106026		100 - 300	0			M9x1			1200	6	100	27/17		
101159		120 - 320	0,35			M9x1			1200	6	100	27/17		
106196		bis 350	0,35			M9x1			1200	6	100	27/17		
3	106197	120 - 280	Rohrflansch	-	0,35	M20x1,5	12/10	M9x1	1200	6	120	27/17		
	106198	140 - 340	ø 21mm	-	0,35	M20x1,5	12/10	M8x1	1200	6	100	27/17		

Zubehör und Ersatzteile für PEL 25S



Abb.	Bestell-Nr.	Beschreibung	Gewinde	ø Rohr (mm)
1	101451	Überwurfmutter	M16x1,5	8
2	101300	Überwurfmutter	M16x1,5	10
3	101450	Doppelkonus	-	8
4	101278	Doppelkonus	-	10

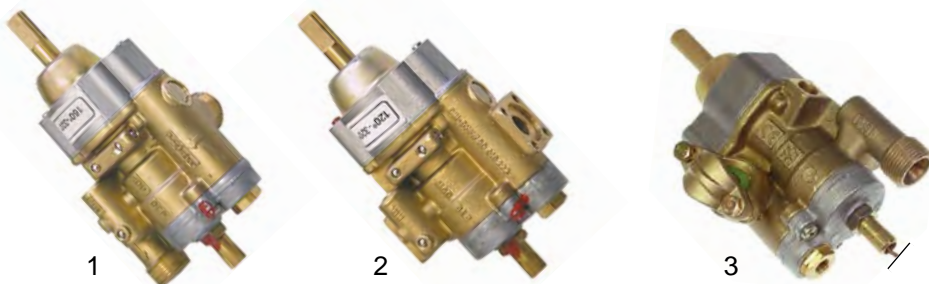

Abb.	Bestell-Nr.	Beschreibung	Gewinde	ø Rohr (mm)
1	100908	Schraube	M10x1	4
2	100909	Schraube	M10x1	6
3	101246	Doppelkonus	-	4
4	101286	Doppelkonus	-	6



Abb.	Bestell-Nr.	Beschreibung
1	101060	Magneteinsatz
2	106199	Magneteinsatzmutter M8x1
	106200	Magneteinsatzmutter M9x1
3	101880	Dichtung für Rohrflansch ø 21mm

Kleinbranddüsen für PEL 25



Pos.	Bestell-Nr.	ø (mm)	Pos.	Bestell-Nr.	ø (mm)	Pos.	Bestell-Nr.	ø (mm)
1	106191	0	8	100428	0,65	15	100407	1,00
2	100259	0,35	9	100429	0,70	16	100435	1,05
3	100281	0,40	10	100432	0,75	17	100436	1,10
4	100414	0,45	11	100409	0,80	18	100437	1,15
5	100390	0,50	12	100410	0,85	19	100438	1,20
6	100391	0,55	13	100433	0,90	20	100413	1,65
7	100392	0,60	14	100434	0,95	21	100776	1,75

Zubehör und Ersatzteile für PEL 24S



Abb.	Bestell-Nr.	Beschreibung	Gewinde	ø (mm)
1	101250	Überwurfmutter	M20x1,5	10
	101251	Überwurfmutter	M20x1,5	12
2	101249	Doppelkonus	-	10
3	101248	Doppelkonus	-	12
4	100908	Schraube	M10x1	4
	100909	Schraube	M10x1	6
5	101246	Klemmring	-	4
6	101286	Klemmring	-	6

Anschlussflansche



Abb.	Bestell-Nr.	Beschreibung	Gewinde	ø (mm)
1	101240	Gasanschlusssteil horizontal	M20x1,5	12/10
2	101241	Gasanschlusssteil vertikal	M20x1,5	12/10
3	101235	Gasanschlusssteil horizontal	M20x1,5	12/10
4	101236	Gasanschlusssteil vertikal	M20x1,5	12/10
5	101365	Gasanschlusssteil horizontal	M20x1,5	12



Abb.	Bestell-Nr.	Beschreibung	Gewinde	ø (mm)
1	101239	Fitting	3/8"	10
2	101461	Schraubensatz	-	-
3	101460	O-Ring	-	-
4	101331	Adapter für gebördelte Leitung 12/10mm	-	-
5	106165	Dichtung für Rohrflansch ø 27mm	-	-



Abb.	Bestell-Nr.	Beschreibung
1	101058	Magneteinsatz
	106199	Magneteinsatzmutter M8x1
2	106200	Magneteinsatzmutter M9x1

Kleinbranddüsen für PEL 24



Pos.	Bestell-Nr.	ø (mm)	Pos.	Bestell-Nr.	ø (mm)	Pos.	Bestell-Nr.	ø (mm)
1	106201	0	12	100627	1,00	23	100699	1,55
2	100455	0,35	13	100628	1,05	24	100250	1,60
3	100448	0,50	14	100649	1,10	25	100251	1,65
4	100458	0,60	15	100655	1,15	26	100263	1,70
5	100459	0,65	16	100659	1,20	27	100264	1,75
6	100493	0,70	17	100664	1,25	28	100265	1,80
7	100494	0,75	18	100666	1,30	29	100266	1,85
8	100497	0,80	19	100667	1,35	30	100267	1,90
9	100546	0,85	20	100674	1,40	31	100268	1,95
10	100597	0,90	21	100677	1,45	32	100273	2,00
11	100598	0,95	22	100679	1,50			

Gasthermostate SABAF



Abb.	Bestell-Nr.	Temperatur (°C)	Gaseingang	ø Rohreingang (mm)	ø Kleinbrand-düse (mm)	Gasausgang 1	Gasausgang 2	Thermoelement-anschluss	Kapillarlänge (mm)	ø Fühler (mm)	Länge Fühler (mm)	L1/L2 (mm)	Achse (mm)
1	101679	300	Rohrflansch	-	0,35	3/8"AG/10mm	M13x1 IG/8mm	M8x1(2x)	850	4	150	34/14	
	101837	300	Rohrflansch	-	0,45	3/8"AG/10mm	M13x1 IG/8mm	M8x1(2x)	850	4	140	34/14	
2	101692	300	M13x1	8	0,50	3/8"AG/10mm	-	M8x1	850	4	140	34/14	
	101173	300	M13x1	8	0,80	3/8"AG/10mm	-	M8x1	850	4	140	37/14	
3	101687	300	Rohrflansch	-	0,45	M13x1 IG/8mm	-	M8x1	850	4	140	17/12	
	101886	300	Rohrflansch	-	0,52	M13x1 IG/8mm	-	M8x1	850	4	140	17/12	
	101181	300	Rohrflansch	-	0,46	M13x1 IG/8mm	-	M8x1	850	4	150	45/27	

Gasthermostate

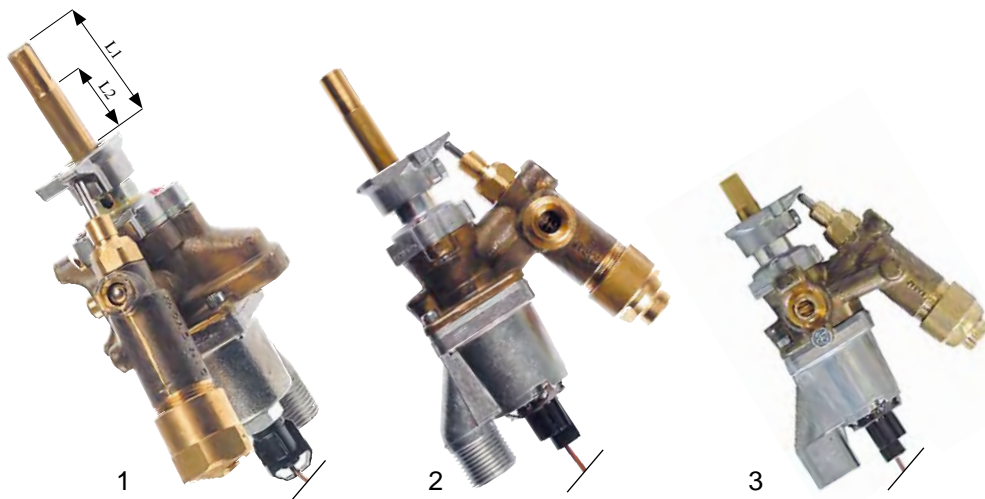

Abb.	Bestell-Nr.	Temperatur (°C)	Gaseingang	ø Rohreingang (mm)	ø Kleinbrand-düse (mm)	Gasausgang 1	Gasausgang 2	Thermoelement-anschluss	Kapillarlänge (mm)	ø Fühler (mm)	Länge Fühler (mm)	L1/L2 (mm)	Achse (mm)
1	101694	300	Rohrflansch	-	0,38	M13x1 IG/8mm	-	M8x1	850	4	150	29/29	
	101695	300	Rohrflansch	-	0,52	M13x1 IG/8mm	-	M8x1	850	4	150	29/29	
2	101836	300	Rohrflansch	-	0,45	3/8"AG/10mm	M13x1 IG/8mm	M8x1 (2x)	850	4	140	34/14	
3	101175	300	Rohrflansch	-	0,35	3/8"AG/10mm	M13x1 IG/8mm	M8x1 (2x)	850	4	150	27/13	

Zubehör und Ersatzteile für SABAF



Abb.	Bestell-Nr.	Beschreibung	Gewinde	ø Rohr (mm)
1	101476	Überwurfmutter	M13x1	8
	101478	Überwurfmutter	3/8"	10
2	101477	Überwurfschraube	M13x1	8
3	101277	Doppelkonus	-	8
	101278	Doppelkonus	-	10

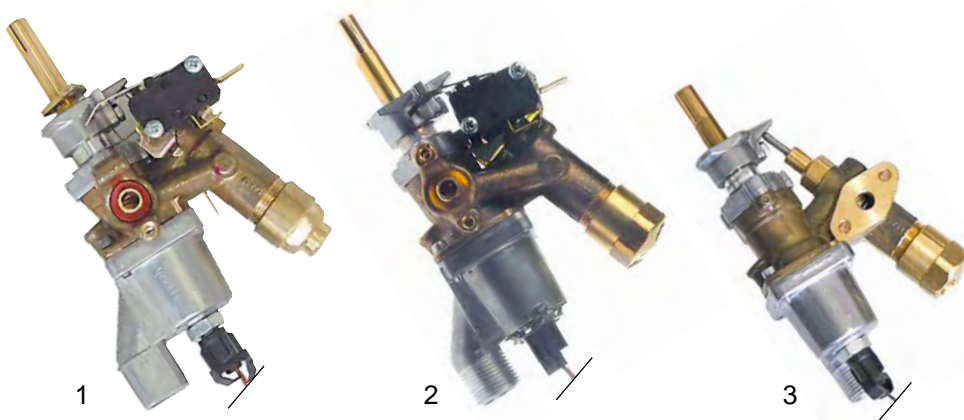

Abb.	Bestell-Nr.	Beschreibung
1	101375	Befestigungsflansch
2	693074	Rohr
3	101376	Flanschdichtung
4	101351	Flanschhalter
5	101751	Flanschhalter
6	346333	Mikroschalter

Gasthermostate COPRECI/IMIT



Abb.	Bestell-Nr.	Hersteller	Temperatur (°C)	Gaseingang	ø Rohreingang (mm)	ø Kleinbranddüse (mm)	Gasausgang	Zündbrenneranschluss	Thermoelementanschluss	Kapillarlänge (mm)	ø Fühler (mm)	Länge Fühler (mm)	L1/L2 (mm)	Achse (mm)
1	101533	Copreci	110	Rohrflansch	-	0,35	3/8"	1/8"	M8x1	1000	7	150	33/12	
	109534	Copreci	300	Rohrflansch	-	0,50	3/8"	1/8"	M8x1	1100	4	84	33/12	
	109051	Copreci	300	Rohrflansch	-	0,60	3/8"	1/8"	M8x1	1100	4	84	33/12	
2	106016	Imit	300	Flansch	-	0,45	1/4"	-	M8x1	840	4	150	23/11	

Zubehör und Ersatzteile für COPRECI/IMIT

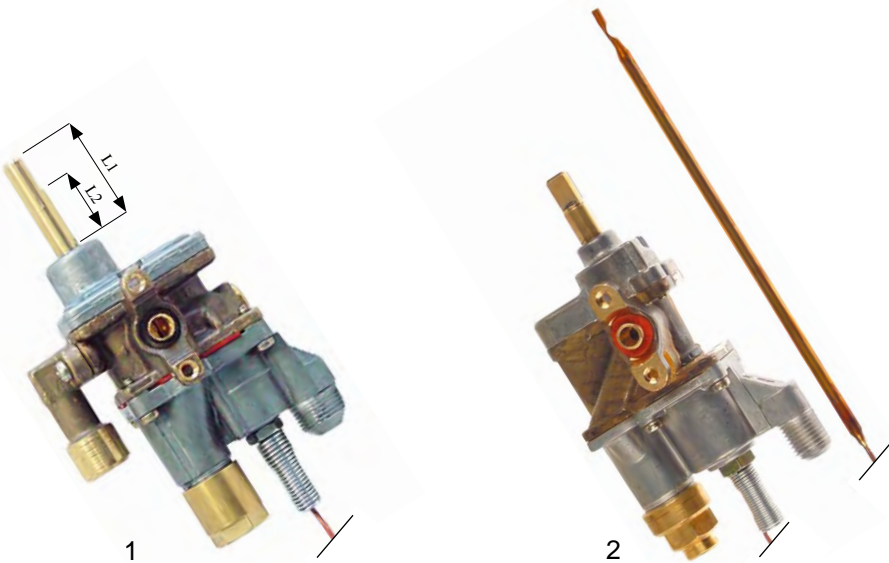

Abb.	Bestell-Nr.	Beschreibung	Abb.	Bestell-Nr.	Beschreibung
1	101060	Magneteinsatz	3	101376	Flanschdichtung
2	101538	Flanschhalter	4	101537	Flanschdichtung

Gasthermostate ROBERTSHAW

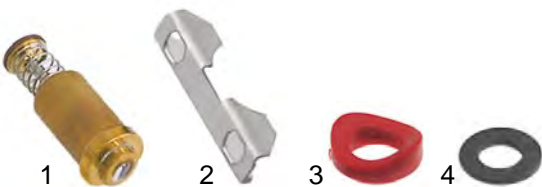

Abb.	Bestell-Nr.	Temperatur (°C)	Temperatur (°F)	Gaseingang/ Gasausgang	Rohreingang/ Rohrausgang	Kapillarlänge (mm)	ø Fühler (mm)	Länge Fühler (mm)	Stopfbuchse	L1 (mm)	Nr. Robertshaw	Achse (mm)
	580054	26 - 93	80 - 200	M11x1 IG	1/4" *	610	9,3	130	3/8"	21	GSE 070240000	
	580051	93 - 190	200 - 375	M11x1 IG	1/4" *	460	6,4	320	1/4"	23	GSE 020180000	
	580052	93 - 190	200 - 375	M11x1 IG	1/4" *	610	9,3	130	3/8"	21	GSH 30240000	
1	580041	93 - 204	200 - 400	M11x1 IG	1/4" *	760	9,3	130	1/4"	21	GSA 60301800	
	580053	93 - 204	200 - 400	M11x1 IG	1/4" *	1530	9,3	130	3/8"	21	GSF 90602300	
	580055	93 - 190	200 - 375	3/8" IG	-	1830	8	190	-	47	GSE 030720000	
	580056	65 - 287	150 - 550	3/8" IG	-	1400	5	390	-	21	FDTOE 30254	
2	580057	bis 287	low-550	1/2" IG	-	1400	5	390	-	21	FDTE 010154	
	580058	65 - 287	150 - 550		-	1400	5	390	-	21		
	580059	93 - 204	200 - 400	3/8" IG	-	600	8	250	-	21	FDL 30136	
3	580060	65 - 287	150 - 550	1/2" IG	-	1250	5	390	-	21	FDO 10748	

*1/4" Rohr amerikanisch = 6,5mm

G Gasthermostate



Abb.	Bestell-Nr.	Temperatur (°C)	Temperatur (°F)	Gaseingang/ Gasausgang	Rohreingang/ Rohrausgang	Kapillarlänge (mm)	ø Fühler (mm)	Länge Fühler (mm)	L1/2 (mm)	Typ	Achse (mm)
1	580061	100 - 300	212 - 572	Flansch	3/8"	720	5	200	25/15	RTGJ	
2	580062	93 - 287	200 - 550	Flansch	7/16" Rohr	1200	5	290	-	BJW	-



Pos.	Bestell-Nr.	Temperatur (°C)	Gaseingang/ Gasausgang	Rohreingang/ Rohrausgang	Kapillarlänge (mm)	ø Fühler (mm)	Länge Fühler (mm)	Stopfbuchse	Thermoelementanschluss	Typ
1	580063	50 - 110	3/4"	3/4"	900	9,5	149	3/8"	ASA 11/32	RGIST 1
	580064	90 - 190	3/4"	3/4"	1200	6	160	3/8"	ASA 11/32	RGIST 2x160
	580065	100 - 320	3/4"	3/4"	900	3,9	223	-	ASA 11/32	RGIST 3
	580066	100 - 450	3/4"	3/4"	900	3,9	210	-	-	RGIST 4

Zubehör und Ersatzteile für ROBERTSHAW

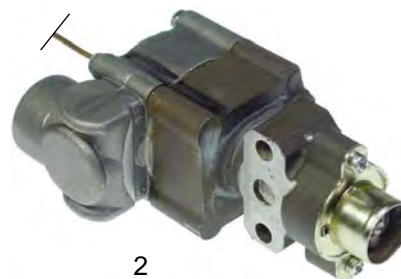

Abb.	Bestell-Nr.	Beschreibung	Gewinde	ø Rohr (mm)
1	106111	Klemmschraube	M11x1	6
	106109	Klemmschraube	M11x1	1/4"
2	106110	Überwurfschraube	M11x1	1/4"
3	101263	Schlitzmutter für Thermoelement	ASA 11/32	-
4	101481	Doppelkonus	-	1/4" CCT

Gasthermostate EGA



Abb.	Bestell-Nr.	Typ	Temperatur (°C)	Gaseingang	ø Rohreingang (mm)	Gasausgang	ø Rohrausgang (mm)	Thermoelementanschluss	Temperatursensor
1	nml*	25213	30 - 100	M15x1	10	3/8"	10	M8x1	Typ 1
	nml*	25213	100 - 200	M15x1	10	3/8"	10	M8x1	Typ 2
	nml*	25213	100 - 250	M15x1	10	3/8"	10	M8x1	Typ 3
	nml*	25213	100 - 300	M15x1	10	3/8"	10	M8x1	Typ 3
	nml*	25213	100 - 300	M15x1	10	M17x1	12	M8x1	Typ 3
2	nml*	21495	100 - 200	M15x1	10	3/8"	10	M8x1	Typ 4
3	nml*	21383	100 - 200	M18x1,5	12	M18x1,5	12	M8x1	Typ 3
	nml*	21383	120 - 300	M18x1,5	12	M18x1,5	12	M8x1	Typ 3

*nicht mehr lieferbar

Zubehör und Ersatzteile für EGA



Abb.	Bestell-Nr.	Temperatur (°C)	Kapillarlänge (mm)	ø Fühler (mm)	Länge Fühler (mm)	Anwendung	Typ Gasthermostat	Stopfbuchse	Typ Temperatursensor
1	102743	bis 125	900	8	160	Bainmarie Wärmeschrank Nudelkocher		-	1
2	102135	bis 200	900	5	150	Friteuse	25213	M12x1	2
	102133	bis 320	900	8	90		21383	-	3
3	102134	bis 320	1250	8	90	Backofen Grillplatte Kippbratpfanne		-	3
4	102197	bis 200	900	5	135	Friteuse	21495	M12x1	4



Abb.	Bestell-Nr.	Beschreibung
1	101230	Magneteinsatzmutter M8x1
	101231	Magneteinsatzmutter M9x1
	101233	Magneteinsatzmutter M10x1
2	101060	Magneteinsatz
3	101058	Magneteinsatz

Gasthermostate BABYSIT

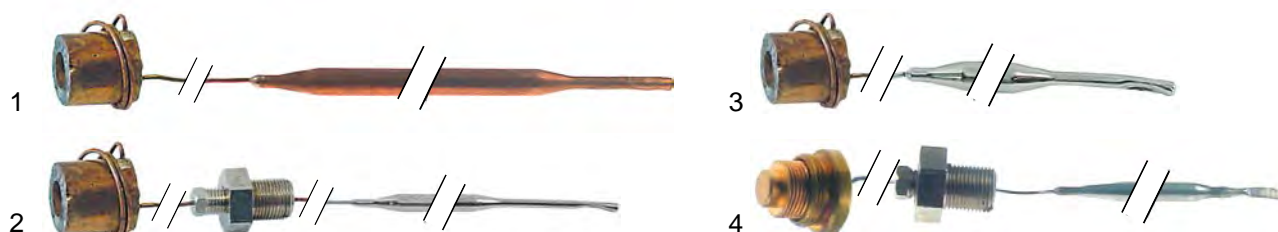

Abb.	Bestell-Nr.	Temperatur (°C)	Gaseingang	Gasausgang	Thermoelementanschluss	Kapillarlänge (mm)	ø Fühler (mm)	Länge Fühler (mm)	Nr. Sit
1	101103	manuell	3/8"	3/8"	M9x1	ohne thermostatische Regelung			0.660.190
	106031	30 - 90	3/8"	3/8"	M9x1	1000	6	230	0.660.193
2	101104	30 - 110	3/8"	3/8"	M9x1	1000	6	237	0.660.806
	101889	30 - 110	3/8"	3/8"	M9x1	1000	6	237	0.660.802
	101105	75 - 315	3/8"	3/8"	M9x1	1000	5	185	0.660.606

Gasthermostate AC2/AC3

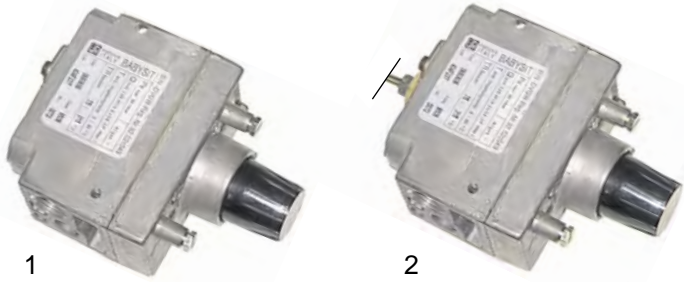

Abb.	Bestell-Nr.	Temperatur (°C)	Gaseingang	Gasausgang	Thermoelementanschluss	Druckregler	Nr. Sit
1	101439	20 - 70	3/8"	3/8"	M9x1	-	0.610.016
2	101440	30 - 70	1/2"	1/2"	M9x1	3 - 18 mbar	0.610.001

Zubehör und Ersatzteile für BABYSIT, Regler AC2/AC3



Abb.	Bestell-Nr.	Beschreibung	Abb.	Bestell-Nr.	Beschreibung
1	100001	Piezozünder	5	102875	Kleinstellschraube ø 0,70mm
2	101055	Magneteinsatz	6	100904	Klemmschraube ø 4mm
3	100903	Magneteinsatzmutter	6	100905	Klemmschraube ø 6mm
4	101333	Stopfen 3/8" mit O-Ring	7	101273	Doppelkonus ø 12mm
5	102874	Kleinstellschraube ohne Loch	8	101276	Verschraubung 3/8" - ø 12mm

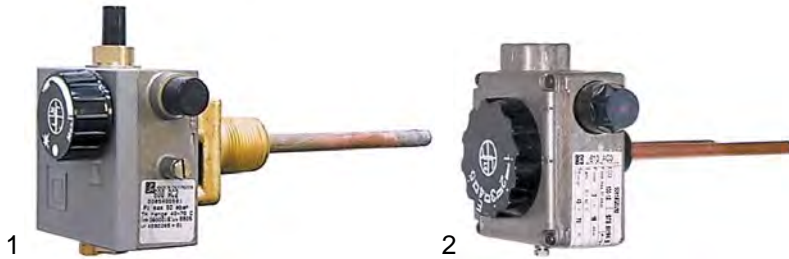

1



2



3

Abb.	Bestell-Nr.	Temperatur (°C)	Gaseingang	Gasausgang	Thermoelement-anschluss	Kapillarlänge (mm)	ø Fühler (mm)	Länge Fühler (mm)	Sensor (S.14)	Druckregler	Stopfbuchse	Nr. Sit
3	101106	manuell	1/2"	3/8"	M9x1	-	-	-	-	-	-	0.710.106
5	101431	13 - 38	1/2"	1/2"	M10x1	1050	8	120	Typ E1	ja	-	0.710.125
2	101910	20 - 90	1/2"	3/8"	M9x1	1050	14,5	19	Typ F2	ja	-	0.710.852
4	101432	30 - 90	1/2"	1/2"	M9x1	1050	8	100	Typ E2	ja	-	0.710.199
1	101130	30 - 100	1/2"	3/8"	M9x1	1050	5	125	Typ A1	nein	-	0.710.850
2	101088	30 - 100	1/2"	3/8"	M9x1	1050	5	125	Typ A1	ja	-	0.710.851
6	106030	40 - 110	1/2"	3/8"	M9x1	1050	5	125	Typ A1	ja	-	0.710.817
7	101689	40 - 110	1/2"	3/8"	M9x1	1050	5	125	Typ A1	nein	-	0.710.819
2	101912	50 - 190	1/2"	3/8"	M9x1	1050	14,4	14,5	Typ F1	ja	-	0.710.752
	101131	50 - 190	1/2"	3/8"	M9x1	1200	5	95	Typ A2	nein	-	0.710.750
1	101135	110 - 190	1/2"	3/8"	M9x1	1050	6	105	Typ A3	nein	-	0.710.756
	101434	110 - 190	1/2"	3/8"	M9x1	1200	5	105	Typ G1	nein	-	0.710.758
	101437	110 - 190	1/2"	3/8"	M9x1	1050	6	105	Typ A3	ja	-	0.710.757
2	101114	110 - 190	1/2"	3/8"	M9x1	1050	14,4	26	Typ F3	ja	-	0.710.754
1	101678	110 - 190	1/2"	3/8"	M9x1	1050	14,4	26	Typ F3	nein	-	0.710.760



4



5



6



7



8



9

Abb.	Bestell-Nr.	Temperatur (°C)	Gaseingang	Gasausgang	Thermoelement-anschluss	Kapillarlänge (mm)	∅ Fühler (mm)	Länge Fühler (mm)	Sensor (S.14)	Druckregler	Stopfbuchse	Nr. Sit
1	101385	60 - 200	3/8"	3/8"	M10x1	1050	5	95	Typ D2	nein	M14x1,5	0.710.724
8	106029	120 - 200	3/8"	3/8"	M9x1	1050	6	105	Typ D1	nein	M14x1,5	0.710.743
1	101132	100 - 340	1/2"	3/8"	M9x1	1050	5	70	Typ B1	nein	-	0.710.650
1	101134	100 - 340	1/2"	3/8"	M9x1	1800	5	70	Typ B1	nein	-	0.710.652
2	101438	100 - 340	1/2"	3/8"	M9x1	1050	5	70	Typ B1	ja	-	0.710.651
11	101796	100 - 340	1/2"	3/8"	M9x1	1800	5	70	Typ B1	ja	-	0.710.657
1	101435	100 - 340	1/2"	3/8"	M9x1	1050	4	72	Typ C1	nein	-	0.710.654
8	102873	140 - 380	1/2"	3/8"	M9x1	1050	4	72	Typ C2	nein	-	0.710.648
9	101768	160 - 380	3/8"	3/8"	M10x1	1050	5	68	Typ B2	nein	-	0.710.618
10	106018	160 - 380	1/2"	3/8"	M10x1	1050	5	68	Typ B2	ja	-	0.710.656
12	102872	160 - 380	3/8"	3/8"	M10x1	1050	5	68	Typ B2	nein	-	0.710.619
2	106239	100 - 340	1/2"	3/8"	M9x1	1050	4	72	Typ C1	-	-	0.710.655

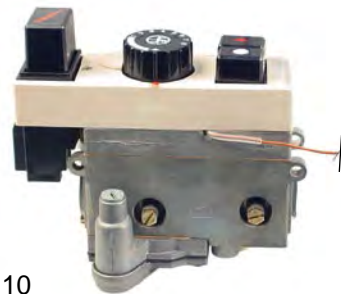

10

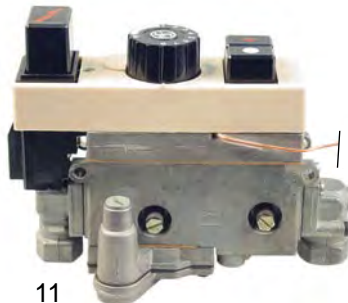

11



12

© GEV 2008

Zubehör und Ersatzteile für MINISIT



Abb.	Bestell-Nr.	Temperatur (°C)	Kapillar-länge (mm)	ø Fühler (mm)	Länge Fühler (mm)	Anwendung	Sensor-typ
1	102106	13 - 38	1050	8	120	Wärmeofen	E1
2	106223	20 - 90	1050	1/4"	19	Bainmarie	F2
1	102117	30 - 90	1050	8	100	Bainmarie	E2
3	102100	30 - 100	1050	5	125	Bainmarie	A1
	102103	50 - 190	1050	5	95	Friteuse	A2
2	nm1**	50 - 190	1050	1/4"	14,5	Friteuse	F1
	102104	110 - 190	1050	1/4"	26	Friteuse	F3
4	102105	110 - 190	1200	5	105	Friteuse	G1
3	102118	110 - 190	1050	6	105	Friteuse	A3
	102844*	60 - 200	1050	5	95	Friteuse	D2
	106225	120 - 200	1050	6	105	Friteuse	D1
	102102	100 - 340	1050	5	70	Backofen/Grill	B1
5	102107*	100 - 340	1050	4	72	Backofen/Grill	C1
	106226	140 - 380	1050	4	72	Backofen/Grill	C2
	106227	160 - 380	1050	5	68	Backofen/Grill	B2

*Kapillarrohr und Fühler, CNS
**nicht mehr lieferbar



Abb.	Bestell-Nr.	Beschreibung
1	101136	Piezozünder mit Abdeckkappe
2	101137	Abdeckkappe
3	100001	Piezozünder

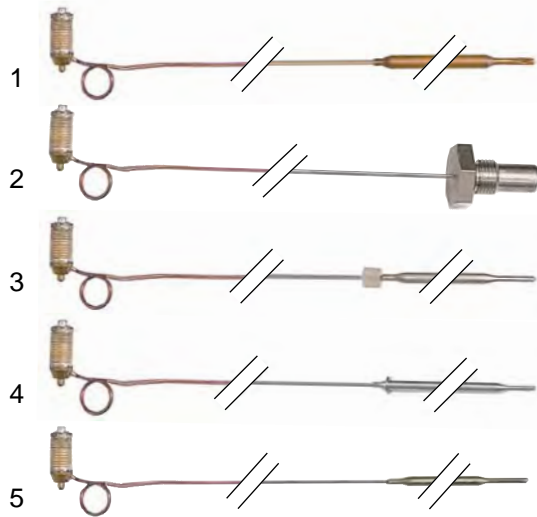

Pos.	Bestell-Nr.	Beschreibung	Bohrung	Pos.	Bestell-Nr.	Beschreibung	Bohrung	Pos.	Bestell-Nr.	Beschreibung	Bohrung
1	102927	Einstellschraube Minimum	0,55	1	102602	Einstellschraube Minimum	1,15	1	102936	Einstellschraube Minimum	2,00
1	102928	Einstellschraube Minimum	0,80	1	102932	Einstellschraube Minimum	1,20	1	102937	Einstellschraube Minimum	2,10
1	102929	Einstellschraube Minimum	0,85	1	102603	Einstellschraube Minimum	1,25	1	102938	Einstellschraube Minimum	2,20
1	102601	Einstellschraube Minimum	0,95	1	102933	Einstellschraube Minimum	1,30	1	102939	Einstellschraube Minimum	2,50
1	102930	Einstellschraube Minimum	1,00	1	102934	Einstellschraube Minimum	1,60	1	102940	Einstellschraube Minimum	2,80
1	102931	Einstellschraube Mnimum	1,10	1	102935	Einstellschraube Mnimum	1,90				

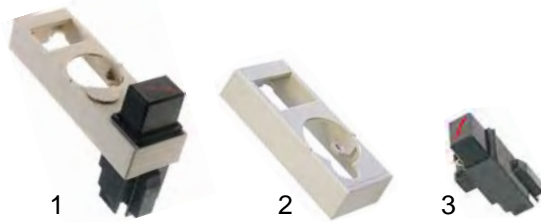

Abb.	Bestell-Nr.	Beschreibung	Gewinde
1	101505	Anschlussflansch	3/8"
2	101504	Anschlussflansch	1/2"
3	101516	Schraube für Flansch 3/8"/1/2"	-
4	101517	Schraube für Flansch 1/2"	-
5	100809	O-Ring	-



Abb.	Bestell-Nr.	Beschreibung
1	110068	Knebel
2	101053	Magneteinsatz M9x1
	101054	Magneteinsatz M10x1



Abb.	Bestell-Nr.	Beschreibung	Innengewinde	Außengewinde
1	101267	Reduzierung	3/8"	1/2"
2	101270	Anschlussnippel	3/8"	3/8"
3	101970	Anschlussnippel	3/8"	1/2"
3	101271	Anschlussnippel	1/2"	3/8"
4	101272	Anschlussnippel	1/2"	3/8"



Abb.	Bestell-Nr.	Beschreibung	Gewinde	ø Rohr (mm)
1	101275	Überwurfschraube	1/2"	16
	101276	Überwurfschraube	3/8"	12
	101279	Überwurfschraube	3/8"	10
2	101274	Klemmring	-	16
	101273	Klemmring	-	12
3	101278	Klemmring	-	10
	100904	Klemmschraube	M10x1	4
	100905	Klemmschraube	M10x1	6
4	100820	Stopfbuchse	M14x1,5	-

Gasthermostate

Gasthermostate EUROSIT



Abb.	Bestell-Nr.	Temperatur (°C)	Gaseingang	Gasausgang	Thermoelementanschluss	Kapillarlänge (mm)	ø Fühler (mm)	Länge Fühler (mm)	Nr. Sit
1	101199	13 - 38	3/8"	3/8"	M10x1	1000	8	120	0.630.025
	101413	30 - 100	3/8"	3/8"	M9x1	1000	5	120	0.630.325
	101188	110 - 190	3/8"	3/8"	M9x1	1000	4	205	0.630.332
	101992	110 - 190	3/8"	3/8"	M9x1	1000	4	205	0.630.337
	101409	40 - 280	3/8"	3/8"	M9x1	1000	4	72	0.630.328
2	101696	60 - 300	3/8"	3/8"	M9x1	1000	4	72	0.630.330
	101915	80 - 320	3/8"	3/8"	M9x1	1000	4	72	0.630.327
	101700	100 - 340	3/8"	3/8"	M9x1	1000	4	72	0.630.331
	101125	100 - 340	3/8"	3/8"	M9x1	1000	4	72	0.630.326
	106035	100 - 340	3/8"	3/8"	M9x1	1000	4	72	0.630.336
	102870	140 - 380	3/8"	3/8"	M9x1	1000	4	72	0.630.205
	101769	100 - 340	3/8"	3/8"	M10x1	1000	4	72	0.630.206

Zubehör und Ersatzteile für EUROSIT



Abb.	Bestell-Nr.	Beschreibung	passend für	Abb.	Bestell-Nr.	Beschreibung	passend für
1	101358	Abdeckung mit Piezozünder		5	101711	Adapter für Knebel ø 10x8mm	Zanussi
2	101392	Adapter für Knebel		6	101712	Adapter für Knebel ø 10x8mm	Olis
	101390	Achse ø 6x4,6mm	Zanussi/Mareno	7	101816	Adapter für Knebel ø 10x8mm	Mareno
3	110357	Achse ø 8x6,5mm	Zanussi/Baron	8	113022	Adapter für Knebel ø 10x8mm	Fagor
	100825	Achse ø 8x6,5mm	Angelo Po	9	110069	Knebel	
4	110358	Adapter für Knebel ø 10x8mm	Zanussi				



Abb.	Bestell-Nr.	Beschreibung
1	101050	Magneteinsatz
2	101273	Doppelkonus ø 10mm
3	101276	Verschraubung 3/8" ø 12mm
4	100904	Klemmschraube ø 4mm
	100905	Klemmschraube ø 6mm
5	101333	Stopfen 3/8" mit O-Ring

Gasthermostate MP/JUNKERS



Abb.	Bestell-Nr.	Temperatur (°C)	Gaseingang	Gasausgang	Druckregler	Thermoelementanschluss	Kapillarlänge (mm)	ø Fühler (mm)	Länge Fühler (mm)	Nr. Junkers/MP
	106216	30 - 110			nein	M10x1				7743-610-501
1	101167	135 - 200	3/8" gewinkelt	3/8" gerade	nein	M10x1	920	6	220	7743-633-201
	106215	170 - 300	3/8" gerade	3/8" gerade	nein	M10x1	820	6	100	7743-633-202
	106217	30-110			ja	M10x1				7743-610-601
2	101177	135 - 200	3/8" gewinkelt	3/8" gerade	ja	M10x1	920	6	220	7743-643-201
	106024	170 - 300	3/8" gerade	3/8" gerade	nein	M10x1	820	6	100	7743-643-402

Zubehör und Ersatzteile für MP/JUNKERS

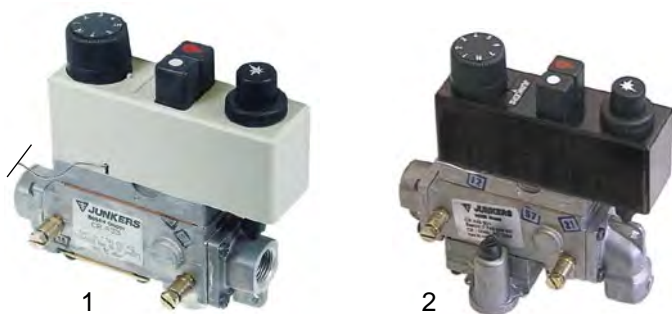

Abb.	Bestell-Nr.	Beschreibung
1	100039	Piezozünder für 106024
2	101060	Magneteinsatz
3	101276	Verschraubung 3/8"/ø 12mm
4	101273	Doppelkegel ø 12mm
	102137	Fühler 135 - 200°C für 101167 + 101177
5	101407	Fühler 130 - 300°C für 106024 + 106215
	102154	Fühler 30 - 110°C für 106216 + 106217

Gasthermostate MERTIK

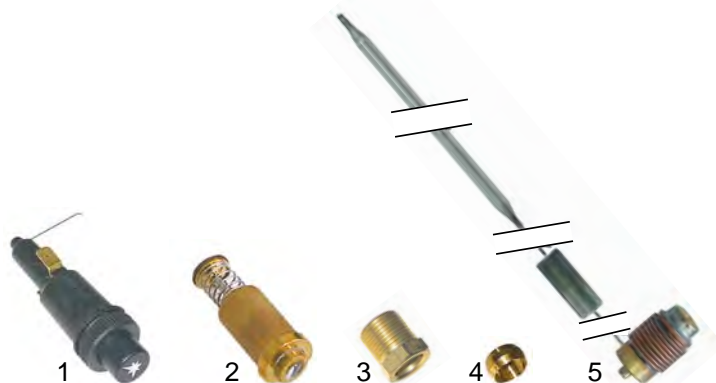

Abb.	Bestell-Nr.	Temperatur (°C)	Gaseingang		Gasausgang		Thermoelement-anschluss	Kapillarlänge (mm)	ø Fühler (mm)	Länge Fühler (mm)	Druckregler	Stopfbuchse	MERTIK-Nr.
			unten	seitlich	unten	seitlich							
1	101966	30 - 110	-	3/8"	-	3/8"	M9x1	720	6	80	-	-	GV31T-C2AKA2K0A0
2	101786	30 - 110	3/8"	3/8"	3/8"	3/8"	M10x1	720	6	80	-	-	GV30-C5AKH2C0
	101982	110 - 190	3/8"	3/8"	3/8"	3/8"	M9x1	720	4	160	5 - 40mbar	-	GV31T-C5AXE2K0Y0
1	101979	110 - 190	3/8"	-	-	3/8"	M9x1	720	4	165	5 - 40mbar	-	GV31T-C3AXE2K0Y0
	101746	100 - 195	3/8"	3/8"	3/8"	3/8"	M10x1	720	6	70	-	1/4"	GV30-C5AÜA2C000
2	106222	100 - 195	3/8"	3/8"	3/8"	3/8"	M10x1	720	6	70	-	1/4"	GV30-C5AÜA2C0L0
	101959	100 - 340	3/8"	-	-	3/8"	M9x1	720	4	68	2,5 - 20mbar	-	GV30T-C3A7A2K6
	101957	100 - 340	3/8"	-	-	3/8"	M9x1	720	4	68	-	-	GV30T-C3A7A2K6A0/1
1	101960	100 - 340	3/8"	-	3/8"	-	M9x1	720	4	72	-	-	GV31T-C1A7AGK000
	106205	100 - 340	3/8"	-	3/8"	-	M9x1	720	4	68	-	-	GV30T-C1A7AMK6Z0
	101745	100 - 340	3/8"	3/8"	3/8"	3/8"	M10x1	720	4	68	-	-	GV30T-C5A7A2C0
2	101744	100 - 340	3/8"	3/8"	3/8"	3/8"	M10x1	720	4	68	-	-	GV30T-C1A7AGC000

Zubehör und Ersatzteile für MERTIK



Abb.	Bestell-Nr.	Beschreibung
1	101276	Verschraubung
2	101273	Doppelkonus
3	106221	Magneteinsatz

Gasthermostate STN3R



Pos.	Bestell-Nr.	Temperatur (°C)	Gaseingang	Gasausgang	Kapillarlänge (mm)	ø Fühler (mm)	Länge Fühler (mm)
1	106207	110	1/2"	1/2"	1200	6,5	200
2	106208	200	1/2"	1/2"	1200	6,5	140
3	106209	300	1/2"	1/2"	1200	6,5	130
1	106210	450	1/2"	1/2"	1200	6,5	250

Zubehör und Ersatzteile für STN3R



Abb.	Bestell-Nr.	Beschreibung
1	106211	Knebel STOP
2	106212	Regelknopf 2 - 8