

## CNS-Flex Schläuche

### Stainless steel-Flex hoses

Norm/Standard

EN50084-DIN-VDE 0700/600

Zulassungen/Registrations: DVGW, SVGW, KIWA, CST Bat

#### Technische Daten:

Arbeitsdruck: 10bar  
 Prüfdruck: 32bar  
 Platzdruck: 95bar  
 Temperatur: max 110°C  
 Nennweite: DN6 Innen 6mm  
 DN8 Innen 8mm  
 DN10 Innen 9,3mm  
 DN12 Innen 12mm

#### Technical data:

Operation pressure: 10bar  
 Test pressure: 32bar  
 Burst pressure: 95bar  
 Temperature: max 110°C  
 Size: DN6 Inside 6mm  
 DN8 Inside 8mm  
 DN10 Inside 9,3mm  
 DN12 Inside 12mm

#### Flachdichtend/Flat seat FD



Pos. Item	Bestell-Nr. Order-No.	Nennweite Size	G1	G2	Länge Length
1	520610	DN6	1/8"	1/8"	300mm
2	520611	DN6	1/8"	1/8"	600mm
3	540265	DN10	3/8"	3/8"	300mm
4	540266	DN10	3/8"	3/8"	500mm
5	520568	DN10	3/8"	3/8"	750mm
6	520567	DN10	3/8"	3/8"	1000mm
7	520612	DN12	1/2"	1/2"	1000mm
8	520613	DN12	1/2"	1/2"	1500mm
9	520614	DN12	3/4"	3/4"	1000mm
10	520615	DN12	3/4"	3/4"	1500mm

#### Flachdichtend/Conical seat KD



Pos. Item	Bestell-Nr. Order-No.	Nennweite Size	G1	G2	Länge Length
1	520569	DN8	3/8"	3/8"	370mm
2	520570	DN8	3/8"	3/8"	2000mm
3	520563	DN10	1/2"	1/2"	1000mm
4	520564	DN10	1/2"	1/2"	1500mm
5	520565	DN10	1/2"	1/2"	2500mm
6	520005	DN10	3/4"	3/4"	1000mm
7	520006	DN10	3/4"	3/4"	2500mm
8	520008	DN12	3/4"	3/4"	1500mm
9	520009	DN12	3/4"	3/4"	2500mm

#### Konischdichtend/Flat seat FD

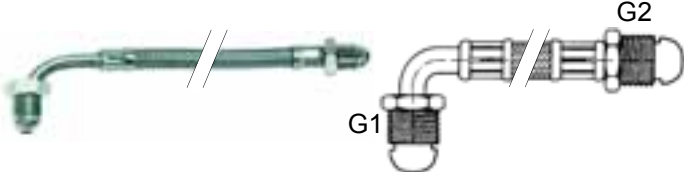

Pos. Item	Bestell-Nr. Order-No.	Nennweite Size	G1	G2	Länge Length
1	520623	DN8	3/8"	3/8"	300mm

#### Konischdichtend/Conical seat KD



Pos. Item	Bestell-Nr. Order-No.	Nennweite Size	G1	G2	Länge Length
1	520616	DN6	1/8"	1/8"	370mm
2	520617	DN6	1/8"	1/8"	1500mm
3	520572	DN8	3/8"	3/8"	500mm
4	520600	DN8	3/8"	3/8"	750mm
5	520601	DN8	3/8"	3/8"	1000mm
6	520602	DN8	3/8"	3/8"	1500mm
7	520603	DN8	3/8"	3/8"	2000mm

#### Konischdichtend/Conical seat KD



Pos. Item	Bestell-Nr. Order-No.	Nennweite Size	G1	G2	Länge Length
1	520604	DN8	3/8"	3/8"	500mm
2	520605	DN8	3/8"	3/8"	1000mm
3	520606	DN8	3/8"	3/8"	1500mm
4	520607	DN8	3/8"	3/8"	2000mm

#### Flachdichtend/Flat seat

#### Konischdichtend/Conical seat



Pos. Item	Bestell-Nr. Order-No.	Nennweite Size	G1	G2	Länge Length
1	520618	DN8	3/8"	3/8"	300mm
2	520619	DN8	3/8"	3/8"	500mm
3	520620	DN8	3/8"	3/8"	750mm
4	520621	DN8	3/8"	3/8"	1000mm
5	520622	DN8	3/8"	3/8"	1500mm

#### Dichtungen/VPE 10 Stck./Gaskets/pack 10 pcs.



Abb. Pict.	Bestell-Nr. Order-No.	G	Abb. Pict.	Bestell-Nr. Order-No.	G
1	521138	3/8"	1	520054	3/4"
1	520055	1/2"	2	520053	3/4"

## Schläuche

### Hoses

Ablaufschläuche, VPE/30m/Outflow hoses, 30m/Pack.



Pos. Item	Bestell-Nr. Order-No.	Maße Measures	Pos. Item	Bestell-Nr. Order-No.	Maße Measures
1	520034	12 x 18mm	4	520037	18 x 25mm
2	520035	14 x 20mm	5	520038	20 x 27mm
3	520036	16 x 23mm			

PVC-Schläuche mit SK-Zeichen/PVC hoses with SK-sign

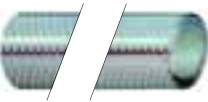

Pos. Item	B.-Nr. O.-No.	Maße Meas.	VPE Pack.	Pos. Item	B.-Nr. O.-No.	Maße Meas.	VPE Pack.
1	520030	6 x 12mm	10m	3	520049	8 x 14mm	10m
2	520048		20m	4	520144	8 x 14mm	20m

Silikon-Schläuche/Silicon hoses



Pos. Item	B.-Nr. O.-No.	Maße Meas.	VPE Pack.	Pos. Item	B.-Nr. O.-No.	Maße Meas.	VPE Pack.
1	520242	4 x 7mm	5m	3	530552	8 x 14mm	5m
2	530550	6 x 10mm	5m	4	530555	12 x 18mm	5m

Silikon-Schläuche mit Glasseidenumflechtung

Glass-silk braided silicon hoses



Pos. Item	B.-Nr. O.-No.	Maße Meas.	VPE Pack.	Pos. Item	B.-Nr. O.-No.	Maße Meas.	VPE Pack.
1	520023	6 x 12mm	5m	2	520024	9,5 x 16mm	5m

Silikon-Schlauch mit Monofilumflechtung

Monofil braided silicon hose



Pos. Item	Bestell-Nr. Order-No.	Maße Meas.	VPE Pack.
1	520025	12 x 19mm	5m

Nylonrohr/Nylon pipes



Pos. Item	B.-Nr. O.-No.	Maße Meas.	VPE Pack.	Pos. Item	B.-Nr. O.-No.	Maße Meas.	VPE Pack.
1	520091	4 x 6mm	2m	4	520251	4 x 6mm	50m
2	520031	4 x 6mm	5m	5	520252	6 x 8mm	5m
3	520026	4 x 6mm	10m	6	520253	6 x 8mm	50m

PVC-Schlauch/PVC hoses

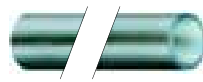

Pos. Item	B.-Nr. O.-No.	Maße Meas.	VPE Pack.	Pos. Item	B.-Nr. O.-No.	Maße Meas.	VPE Pack.
1	520090	4 x 6mm	2m	7	570046	5 x 8mm	100m
2	520026	4 x 6mm	10m	8	520028	6 x 8mm	10m
3	570026	4 x 6mm	100m	9	570028	6 x 8mm	100m
4	520027	4 x 7mm	10m	10	520029	6 x 9mm	10m
5	570027	4 x 7mm	100m	11	570029	6 x 9mm	100m
6	520046	5 x 8mm	10m	12	520022	8 x 12mm	10m

Druckminderer/Reduction valve



Abb. Pict.	Bestell-Nr. Order-No.	Beschreibung Description
1	520271	Druckminderer, 1/2", Export Reduction valve, 1/2", Export
2	520265	Druckminderer, 1/2", DVGW zugelassen Reduction valve, 1/2", DVGW registered
3	520270	Manometer, 0 - 15bar

Schlauchschellen CNS/Hose tightening stainless steel



1	Band und Gehäuse-CNS 1.4016 Schraube-stahlverzinkt, chromatiert, Bandbreite 9 mm Belt and case-stainless steel 1.4016 Screw Zinc-coated Steel Chromed, belt width 9mm	2	komplett aus CNS WN 1.4301 Bandbreite 9 mm Stainless steel WN 1.4301/cpl. Chromed, belt width 9mm
---	--	---	--

Abb. Pict.	B.-Nr. O.-No.	VPE Pack	Bereich Area	Abb. Pict.	B.-Nr. O.-No.	VPE Pack	Bereich Area
1	520110	10	8 - 12	1	520116	5	32 - 50
1	520111	10	10 - 16	1	520117	5	40 - 60
1	520112	10	12 - 20	1	520118	5	50 - 70
1	520113	10	16 - 25	1	520119	5	60 - 80
1	520114	10	20 - 32	2	520120	1	12 - 20
1	520115	10	25 - 40	2	520121	1	16 - 25

Schlauchschellen-Band/Schloss/  
Hose tightening belts/locks



Pos. Item	Bestell-Nr. Order-No.
1	520127

# Mechanische Teile/Mechanical parts

## Schlauchtüllen Rubberholder



Abb. Pict.	Bestell-Nr. Order-No.	G G	D D	Abb. Pict.	Bestell-Nr. Order-No.	G G	D D
1	520672	3/8"	10mm	3	520675	3/8"	10mm
2	520673	1/2"	12mm	3	520677	3/8"	12mm
3	520674	3/8"	8mm	3	520676	1/2"	12mm

## Lötnippel Überwurfmutter Soldering nipples Union nut



Abb. Pict.	Bestell-Nr. Order-No.	R R	Abb. Pict.	Bestell-Nr. Order-No.	G G	D D
1	520653	6mm	2	520656	1/4"	6mm
1	520652	8mm	2	520655	3/8"	13mm
1	520651	10mm	2	520654	1/2"	12mm
1	520650	12mm				

## Doppelkegel Überwurfmutter Double cone Union nut



Abb. Pict.	Bestell-Nr. Order-No.	R R	Abb. Pict.	Bestell-Nr. Order-No.	G G	D D
1	101286	6mm	2	520660	1/4"	6mm
1	101277	8mm	2	520659	3/8"	8mm
1	101278	10mm	2	101478	3/8"	10mm
1	101273	12mm	2	520657	1/2"	12mm

## Doppelnippel Reduziernippel Double nipples Reducing nipples



Abb. Pict.	Bestell-Nr. Order-No.	G G	Abb. Pict.	Bestell-Nr. Order-No.	G G
1	520661	1/8"	2	520680	1/4" - 1/8"
1	520662	1/4"	2	520681	3/8" - 1/8"
1	520663	3/8"	2	520682	3/8" - 1/4"
1	520664	1/2"	2	520683	1/2" - 3/8"
1	520665	3/4"	2	520218	3/4" - 3/8"
			2	520208	3/4" - 1/2"

## Reduzierungen Reductions



Pos. Item	Bestell-Nr. Order-No.	G1 G1	G2 G2	Pos. Item	Bestell-Nr. Order-No.	G1 G1	G2 G2
1	520690	1/8"	1/4"	7	520696	3/8"	1/2"
2	520691	1/8"	3/8"	8	520697	3/8"	3/4"
3	520692	1/4"	1/8"	9	520698	1/2"	3/8"
4	520693	1/4"	3/8"	10	520699	1/2"	1/2"
5	520694	3/8"	1/4"	11	520700	1/2"	3/4"
6	520695	3/8"	3/8"				

## Endkappen Ending caps



Abb. Pict.	Bestell-Nr. Order-No.	G G	Abb. Pict.	Bestell-Nr. Order-No.	G G
1	520701	1/8"	2	520705	1/8"
1	520702	1/4"	2	520706	1/4"
1	520703	3/8"	2	520707	3/8"
1	520704	1/2"	2	520708	1/2"

## T-Stücke T-pieces



Pos. Item	Bestell-Nr. Order-No.	G G	Pos. Item	Bestell-Nr. Order-No.	G G
1	520710	1/4"	3	520712	1/2"
2	520711	3/8"			

## Minikugelhähne Small ball taps



Abb. Pict.	Bestell-Nr. Order-No.	G G	Abb. Pict.	Bestell-Nr. Order-No.	G G
1	520720	1/8"	2	520721	1/8"
1	520294	1/4"	2	520722	1/4"
1	520295	3/8"	2	520723	3/8"
1	520296	1/2"	2	520724	1/2"
1	520297	3/4"	2	520725	3/4"

## Ventile Valves

Sicherheitsventile, 1,8bar/Safety valves, 1,8bar



Abb. Pict.	Bestell-Nr. Order-No.	G G	Abb. Pict.	Bestell-Nr. Order-No.	G G
1	529331	1/8"	3	529312	3/8"
2	529307	1/4"	4	529306	1/2"



Abb. Pict.	Bestell-Nr. Order-No.	G G	Abb. Pict.	Bestell-Nr. Order-No.	G G
1	529309	M18 x 1,5	3	529330	M22 x 30
2	529308	M19 x 1			

Plombiert/Sealed

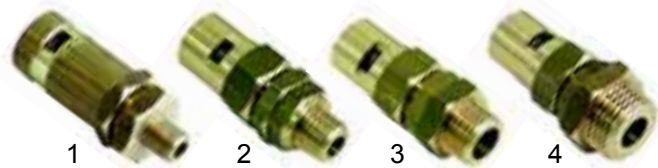

Abb. Pict.	Bestell-Nr. Order-No.	G G	Zulassung Restriction
1	529316	3/8"	Ispel
2	529332	3/8"	TÜV
3	529310	1/2"	Ispel

Diverse/Diverse



Abb. Pict.	Bestell-Nr. Order-No.	Beschreibung Description	Zulassung Restriction	Passend für Suitable for
1	529346	3/8 Innen/Inside		Nuova Simonelli
2	529338	3/8", 1,5bar	TÜV	Brasilia
3	529827	1/2"		Reneka

Entlüftungsventile/Empty valve



Abb. Pict.	Bestell-Nr. Order-No.	G G	Pos. Item	Bestell-Nr. Order-No.	G G
1	529303	1/4"	3	529305	3/8"
2	529304	1/4"			

Cu-Dichtung/Cu-Gasket



Abb. Pict.	Bestell-Nr. Order-No.	G G	Abb. Pict.	Bestell-Nr. Order-No.	G G
1	529361	1/4"	3	529348	M19
2	529349	3/8"	4	529360	1/2"

Rückschlagventil/Return valve



Abb. Pict.	Bestell-Nr. Order-No.	G G	L/mm	Abb. Pict.	Bestell-Nr. Order-No.	G G	L/mm
1	529335	1/8"	30	3	529301	3/8"	38
2	529340	1/4"	30	4	528790	3/8"	43

Reduziert/Reduced



Abb. Pict.	Bestell-Nr. Order-No.	Ein On	Aus Out	L/mm
1	528368	1/8"	1/4"	40
2	528365	1/8"	3/8"	40
3	529322	3/8"	1/4"	30

Expansionsventil/Expansion valve



Abb. Pict.	Bestell-Nr. Order-No.	G1 G1	G2 G2	L/mm
1	529341	1/8"	1/8"	24
2	529378	1/4"	1/4"	37
3	529337	1/4"	3/8"	49



Pos. Item	Bestell-Nr. Order-No.	G1 G1	G2 G2	L/mm
1	529329	3/8"	Ø8mm	55

## Distanzeinlagen Space insertions

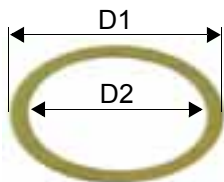

Pos. Item	Bestell-Nr. Order-No.	D1/ mm	D2/ mm	Passend für Suitable for
1	528048	63	53	San Marco
2	528084	64	55	Spaziale
3	528046	67	58	Astoria, Bezzera, Brasilia
4	528068	69	57	Carimali
5	528050	73	59	Astoria, Auora, Gaggia
6	528033	71	58	Brasilia, Cimbali, Espresso, Expobar, Faema, Futurmat, Italcrem, Mairali, Marzocco, Nuova Simonelli, Pavoni, Vibiemme, VFA-Express, Visacrem, Wega

## Siebträgerdichtung Filter holder gasket

Norm/Standard

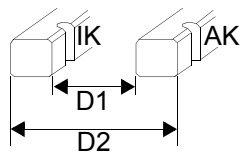
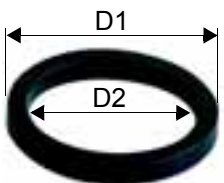

IK: Innenkerbe/  
Inside notch  
AK: Außenkerbe/  
Outside notch

Pos. Item	B.-Nr. O.-No.	D1/ mm	D2/ mm	H/ mm	Kerbe Notch	Passend für Suitable for
1	528038	64	52	5,5	-	San Marco
2	528041	64	52	6,5	-	San Marco
3	528059	64	53	5	-	Marcfi/ancas
4	528043	66	56	6	-	Astoria, Brasilia
5	528044	69	57	7,5	-	Carimali
6	528035	70	56	8	-	Cimbali
7	528076	70	56	8	AK	Cimbali
8	528083	70	57	8	-	Solenry
9	528040	70	57	8	AK	Brasilia
10	528042	72	56	8	-	Astoria, Gaggia
11	528054	72	56	8	AK	Astoria, Gaggia
12	528063	72	56	8,5	-	Astoria, Gaggia
13	528069	72	58	4,5	-	Nuova Simonelli
14	528047	72	58	7	-	
15	528060	72	58	7	-	Marcfi/Ancas
16	528061	72	58	9	-	Marcfi/Ancas
17	528049	72	56	9	AK	Auora
18	528030	73	57	8	-	Azkoyen, Bezzera, Brasilia, Conti, Espresso, Expobar, Faema, Futurmat, Italcrem, Mairali, Pavoni, Vibiemme, VFA-Express, Visacrem, Wega
19	528070	73	57	8	IK	
20	528031	73	57	8,5	-	
21	528053	73	57	8,5	AK	
22	528032	73	57	9	-	
23	528034	72	57	8	AK	
24	528087	74	57	9	-	Unic
25	528037	74	58	9	-	Reneka

## Siebträgerdichtung Filter holder gasket

Mit Wulst/With roll

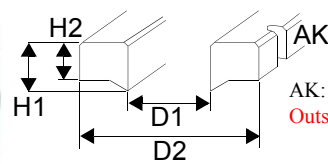
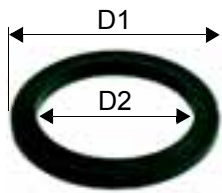

AK: Außenkerbe/  
Outside notch

Pos. Item	Bestell-Nr. Order-No.	D1/ mm	D2/ mm	H1/ mm	H2/ mm	Passend für Suitable for
1	528065	72	55	8,5	6,5	Marzocco
2	528066	72	55	9	7	Marzocco

## Konisch/Conical

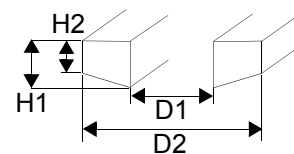
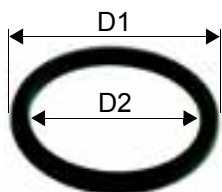

Pos. Item	Bestell-Nr. Order-No.	D1/ mm	D2/ mm	H1/ mm	H2/ mm	Passend für Suitable for
1	528067	66	56	6	4	Brasilia
2	528036	71	56	8,5	6,5	Cimbali

## O-Ring/O-ring

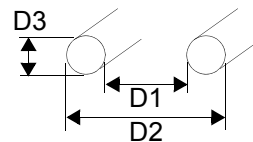
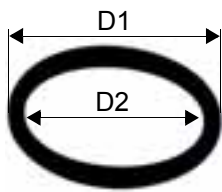

Pos. Item	Bestell-Nr. Order-No.	D1/ mm	D2/ mm	D3/ mm	Passend für Suitable for
1	528045	66	56	5,34	Brasilia, Elektra

## Duschsiebe Shower sieves

Norm/Standard

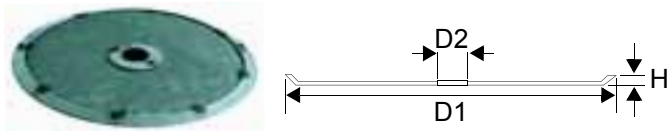

Pos. Item	Bestell-Nr. Order-No.	D1/ mm	D2/ mm	H/ mm	Passend für Suitable for
1	529088	48	5	2	San Marco
2	528884	50,2	3,2	1,5	Solenry
3	529084	51,5	5,5	1,5	Astoria, Gaggia, Cimbali
4	528415	52	5	1,2	Brasilia
5	529089	52	6	1,5	Brasilia, Cimbali
6	529193	52	6,2	2	Elektra
7	528856	52	6,2	2	Reneka

Mit Aufkantung und Mittelloch/With edge and center hole

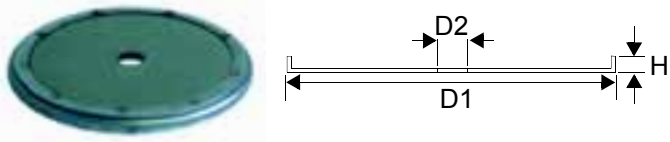

Pos. Item	Bestell-Nr. Order-No.	D1/ mm	D2/ mm	H/ mm	Passend für Suitable for
1	529091	57	6,2	4	Carimali, Bezzera, Marzocco
2	529085	58	5	3,5	Pavoni, Rancilio
3	528472	58	6	9	Conti
4	529092	57	5,5	5	Auora
5	529144	56	5,5	6	Nuova, Simonelli, Pavoni

Mit Aufkantung/With edge

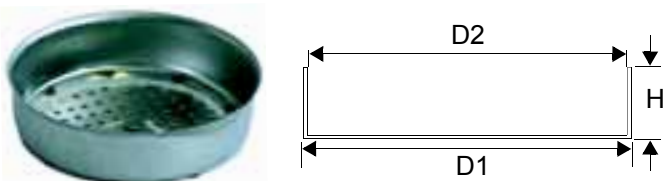

Pos. Item	Bestell-Nr. Order-No.	D1/ mm	D2/ mm	H/ mm	Passend für Suitable for
1	529080	60	57	12	Azkoyen, Brasilia, Expobar, Pavoni, Espresso, Faema, Futurmat, Italcrem, Mairali, Vibiemme, Visacrem, VFA-Express, Wega

2-teilig/2-parts

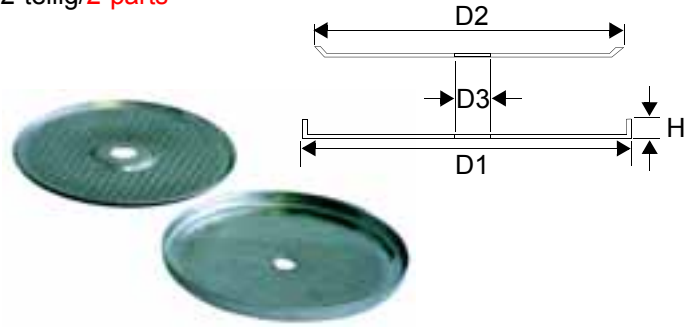

Pos. Item	Bestell-Nr. Order-No.	D1/ mm	D2/ mm	D3/ mm	H/ mm	Passend für Suitable for
1	529090	52	49,5	5	3,5	Spaziale

Blindsiebe/Blind sieves

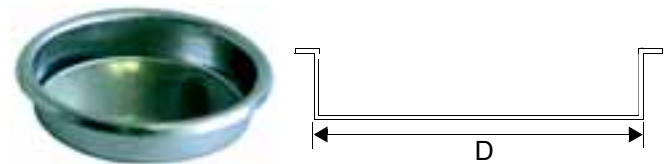

Pos. Item	Bestell-Nr. Order-No.	D/ mm	Passend für Suitable for
1	529023	60	Universal
2	529028	57	San Marco
3	529064	55	Spaziale

Membranen, Federn/Membrans, Springs



Abb. Pict.	Bestell-Nr. Order-No.	Beschreibung Description	Passend für Suitable for
1	529024	Membrane/Membrane	Universal
2	529079	Feder/Spring	Universal
2	529065	Feder/Spring	San Marco, Spaziale

Kaffesiebe/Coffee sieves  
Economy

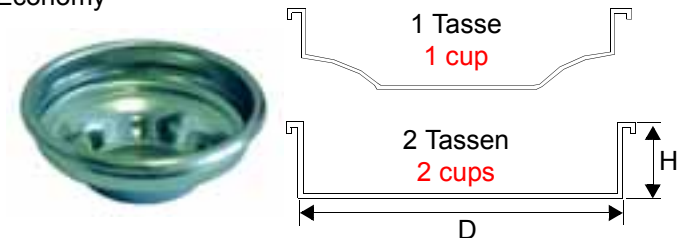

Pos. Item	Bestell-Nr. Order-No.	Tassen Cups	D/ mm	H/ mm	Passend für Suitable for
1	529075	1/7gr.	60	22	Astoria, Auora, Bezzera, Brasilia, Faema, Futurmat, Marzocco, Pavoni, Nuova Simonelli, Vibiemme, Wega
2	529076	2/14gr.	60	24	
3	529077	1/7gr.	60	22	Carimali, Gaggia, Italcrem, Visacrem
4	529078	2/14gr.	60	24	

## Kaffesiebe

### Shower sieves

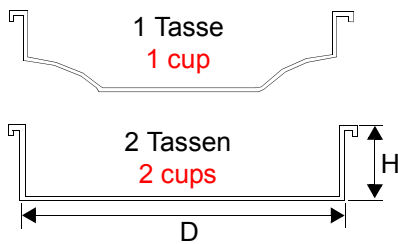

Pos. Item	Bestell-Nr. Order-No.	Tassen Cups	D/ mm	H/ mm	Passend für Suitable for
1	529012	1/6gr.	60	20	Astoria, Auora, Bezzera, Brasilia, Azkoyen, Conti, Elektra, Espresso, Expobar, Faema, Futurmat, Mairali, Marzocco, Nuova Simonelli, Pavoni, Reneka, Vibiemme, VFA-Express, Wega
2	529011	1/7gr.	60	22	
3	529014	2/12gr.	60	22	
4	529013	2/14gr.	60	24	
5	529021	1/7gr.	60	24	Carimali, Gaggia, Italcrem, Visacrem
6	529022	2/14gr.	60	24	
7	529018	1/6gr.	60	18	Cimbali
8	529017	1/7gr.	60	20	Cimbali
9	529020	2/12gr.	60	18	Cimbali
10	529019	2/14gr.	60	20	Cimbali
11	529098	1/7gr.	60		Marcfi/Ancas
12	529099	2/14gr.	60		Marcfi/Ancas
13	529100	1/7gr.	57		Marcfi/Ancas
14	529101	2/14gr.	57		Marcfi/Ancas
15	529015	1/7gr.	60	20	Rancilio
16	529016	2/14gr.	60	22	Rancilio
17	529026	1/7gr.	58	24	San Marco
18	529027	2/14gr.	58	27	San Marco
19	529103	1/7gr.	57	17	Solenry
20	529104	2/14gr.	57	22	Solenry
21	529029	1/7gr.	56	27	Spaziale
22	529030	2/14gr.	56	27	Spaziale
23	529210	1/7gr.	60	21	Unic
24	529211	2/14gr.	60	23	Unic

## Siebträger

### Filter holders



Pos. Item	Bestell-Nr. Order-No.	G1	G2	D/ mm	Passend für Suitable for
1	529059	3/8"	M12	62	Astoria, Bezzera, Brasilia, Vibiemme
2	529072	3/8"	M12	62	Auora
3	529041	3/8"	M12	61,5	Brasilia, Faema, Futurmat, Italcrem, Mairali, VFA-Express, Visacrem
4	529069	3/8"	M10	60,2	Carimali
5	529051	2-Loch 2-hole	M10	60	Cimbali
6	529052	3/8"	M10	60	Cimbali, Faema
7	529212	3/8"	M12	60,2	Conti
8	529198	3/8"	M12	61,5	Elektra
9	529058	3/8"	M12	62	Espresso, Expobar, Wega
10	529055	3/8"	M10	61,2	Gaggia, Italcrem, Visacrem
11	529204	3/8"	M12	62	Marzocco
12	529205	3/8"	M10	62	Marzocco
13	529071	3/8"	M10	61	Nuova Simonelli
14	529034	3/8"	M10	60,2	Pavoni
15	529050	3/8"	M12	62	Rancilio
16	529033	3/8"	M10	60,2	Reneka
17	529057	3/8"	M10	58	San Marco
18	529156	1/4"	M10	57,7	Solenry
19	529060	3/8"	M12	60,2	Spaziale
20	529212	3/8"	M12	60,2	Unic

## Griffe/Handles



Pos. Item	Bestell-Nr. Order-No.	G	Passend für Suitable for
1	529045	M12	Universal
2	529053	M10	Universal

## Gruppenzubehör

### Group accessories

Ausläufe/Outflow pipes



Abb. Pict.	Bestell-Nr. Order-No.	Beschreibung Description	G G
1	529002	1 Weg, gerade/kurz 1 way, straight/short	3/8"
2	529001	1 Weg, gerade/lang 1 way, straight/long	3/8"
3	529005	1 Weg, gebogen/kurz 1 way, straight/short	3/8"
4	529003	1 Weg, gebogen/lang 1 way, curved/long	3/8"
5	529004	1 Weg, gebogen/geschlossen 1 way, curved/closed	3/8"



Abb. Pict.	Bestell-Nr. Order-No.	Beschreibung Description	G G
1	529008	2 Wege Abstand, 44mm 2 ways distance, 44mm	3/8"
2	529007	2 Wege Abstand, 55mm kurz 2 ways distance, 55mm short	3/8"
3	529006	2 Wege Abstand, 55mm lang 2 ways distance, 55mm long	3/8"



Abb. Pict.	Bestell-Nr. Order-No.	Beschreibung Description	G G
1	529161	2 Wege Abstand, 55mm kurz regulierbar 2 ways distance, 55mm short adjustable	3/8"
2	529165	2 Wege Abstand, 55mm lang regulierbar 2 ways distance, 55mm long adjustable	3/8"

## Gruppenzubehör

### Group accessories

Ausläufe/Outflow pipes



Abb. Pict.	Bestell-Nr. Order-No.	Beschreibung Description	G G
1	529162	1 Weg 1 way	1/4"
2	529163	2 Wege Abstand 1 way distance	1/4"
3	529009	1 Weg 1 way	2 Lochbefestigungen
4	529010	2 Wege 2 ways	2 Lochbefestigungen

## Dampfdüsen/Steam nozzles



Abb. Pict.	Bestell-Nr. Order-No.	Material Material	G G	L/mm
1	529787	Messing/verchromt Brass/chromed	M6 x 1	18
2	529788	Messing Brass	M6 x 1	18
3	529513	Messing/verchromt Brass/chromed	M10 x 1	16
4	529573	Messing/verchromt Brass/chromed	M10 x 1	17



Abb. Pict.	Bestell-Nr. Order-No.	Material Material	G G	L/mm
1	528828	Messing/verchromt Brass/chromed	M9	25
2	529801	CNS Stainless steel	1/8"	28
3	529861	CNS Stainless steel	M8,5 x 0,75	33



## Manometer

### Manometers

Monoskala/Mono scale



Abb. Pict.	Best.-Nr. Ord.-No.	G	Druck Pressure	Einbau-Ø Fitting-Ø	Passend für Suitable for
1	541205	1/8"	3bar	42	Faema
2	541206	1/8"	16bar	42	Faema
3	541261	1/8"	2,5bar	44	Faema



Abb. Pict.	Best.-Nr. Ord.-No.	G	Druck Pressure	Einbau-Ø Fitting-Ø	Passend für Suitable for
1	541229	1/8"	3bar	42mm	Gaggia, Carimali
2	541228	1/8"	15bar	42mm	Gaggia, Carimali
3	541258	1/8"	3bar	42mm	Azkoyen
4	541265	1/8"	2,5bar	42mm	Bezzera



Abb. Pict.	Best.-Nr. Ord.-No.	G	Druck Pressure	Einbau-Ø Fitting-Ø	Passend für Suitable for
1	541242	1/4"	3bar	50mm	Italcrem
2	541243	1/4"	24bar	50mm	Italcrem
3	541217	1/8"	3bar	50mm	Gaggia
4	541216	1/8"	15bar	50mm	Gaggia



Abb. Pict.	Best.-Nr. Ord.-No.	G	Druck Pressure	Einbau-Ø Fitting-Ø	Passend für Suitable for
1	541244	1/8"	3bar	50mm	Italcrem, Visacrem, San Marco
2	541246	1/8"	12bar	50mm	Italcrem, Visacrem
3	541245	1/8"	24bar	50mm	Italcrem, Visacrem



Abb. Pict.	Best.-Nr. Ord.-No.	G	Druck Pressure	Einbau-Ø Fitting-Ø	Passend für Suitable for
1	541289	1/8"	3bar	50mm	Reneka
2	541290	1/8"	16bar	50mm	Reneka



Abb. Pict.	Best.-Nr. Ord.-No.	G	Druck Pressure	Einbau-Ø Fitting-Ø	Passend für Suitable for
1	541281	1/8"	20bar	52mm	Solenry, Futurmat
2	541225	1/4"	3bar	52mm	Astoria
3	541274	1/4"	3bar	52mm	Auora



Abb. Pict.	Best.-Nr. Ord.-No.	G	Druck Pressure	Einbau-Ø Fitting-Ø	Passend für Suitable for
1	541214	1/8"	3bar	54mm	Gaggia
2	541215	1/8"	16bar	54mm	Gaggia
3	541276	1/8"	2,5bar	60mm	Cimbali



Abb. Pict.	Best.-Nr. Ord.-No.	G	Druck Pressure	Einbau-Ø Fitting-Ø	Passend für Suitable for
1	541212	1/8"	2,5bar	60mm	Cimbali
2	541213	1/8"	15bar	60mm	Cimbali
3	541275	1/8"	2,5bar	60mm	Cimbali

## Manometer

### Manometers

Monoskala/Mono scale

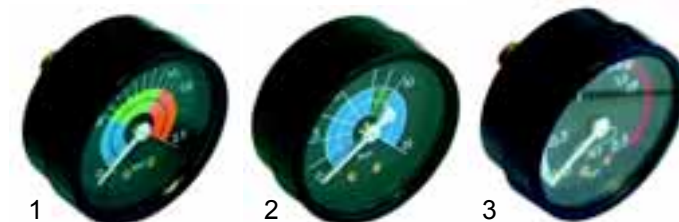

Abb. Pict.	Best.-Nr. Ord.-No.	G	Druck Pressure	Einbau-Ø Fitting-Ø	Passend für Suitable for
1	541231	1/4"	3bar	60mm	Bezzera
2	541286	1/8"	3bar	60mm	Pavoni
3	541280	1/8"	3bar	60mm	Expobar



Pos. Item	Best.-Nr. Ord.-No.	G	Druck Pressure	Einbau-Ø Fitting-Ø	Passend für Suitable for
1	541250	1/4"	3bar	65mm	Marcfi/Ancas



Abb. Pict.	Best.-Nr. Ord.-No.	G	Druck Pressure	Einbau-Ø Fitting-Ø	Rahmen Frame	Passend für Suitable f.
1	541268	1/8"	2,5bar	58mm	60x47mm	Brasilia
2	541207	1/8"	15bar	61mm	60x47mm	Faema
3	541277	1/4"	3bar	62mm	38x38mm	Conti



Pos. Item	Best.-Nr. Ord.-No.	G	Druck Pressure	Einbau-Ø Fitting-Ø	Passend für Suitable for
1	541253	1/8"	3bar	44mm	Elektra
2	541254	1/8"	3bar	44mm	Elektra
3	541278	1/4"	16bar	62mm	Conti

Rechteckig/rectangular



Abb. Pict.	B.-Nr. O.-No.	G	Druck Press.	Einb.-Ø Fitt.-Ø	Rahmen Frame	Passend f. Suitable f.
1	541283	1/4"	3bar	52mm	79x56mm	Gaggia, Solenry
2	541284	1/4"	15bar	52mm	79x56mm	Gaggia
3	541282	1/4"	2bar	52mm	79x56mm	Futurmat



Abb. Pict.	B.-Nr. O.-No.	G	Druck Press.	Einb.-Ø Fitt.-Ø	Rahmen Frame	Passend f. Suitable f.
1	541247	1/4"	2bar	52mm	79x56mm	Mairali
2	541230	1/8"	2bar	55mm	61x61mm	Carimali

Mit Frontbefestigung/With front attachment



Abb. Pict.	Best.-Nr. Ord.-No.	G	Druck Pressure	Einbau-Ø Fitting-Ø	Passend für Suitable for
1	541200	1/8"	3bar	55mm	Faema, Futurmat
2	541201	1/8"	16bar	55mm	Faema, Futurmat

## Manometer

### Manometers

Doppelskala/Double scale

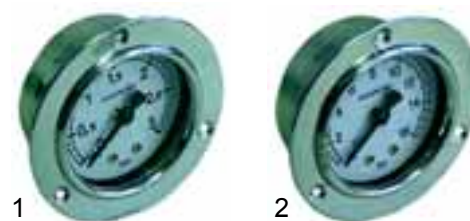

Abb. Pict.	Bestell-Nr. Order-No.	G	Druck Press.	Einb.-Ø Fitt.-Ø	Passend für Suitable für
1	541255	1/8"	2/16bar	60mm	Elektra
2	541264	1/8"	2/16bar	60mm	Elektra



Abb. Pict.	Bestell-Nr. Order-No.	G	Druck Press.	Einb.-Ø Fitt.-Ø	Passend für Suitable für
1	541210	1/8"	2,5/15bar	60mm	Cimbali M15
2	541211	1/8"	2,5/15bar	60mm	Cimbali M20
3	541220	1/8"	3/15bar	63mm	San Marco

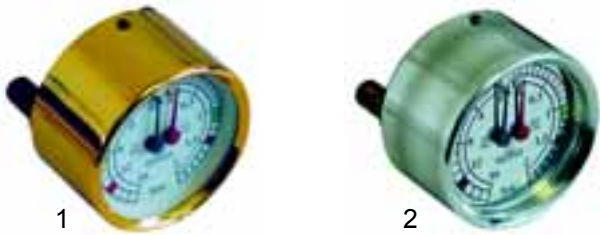

Abb. Pict.	Bestell-Nr. Order-No.	G	Druck Press.	Einb.-Ø Fitt.-Ø	Passend für Suitable für
1	541222	1/8"	2,5/20bar	60mm	Vibiemme
2	541270	1/8"	2,5/6bar	60mm	Brasilia
3	541208	1/8"	3/16bar	60mm	Expobar, Futurmat, Mairali, VFA-Express



Abb. Pict.	Bestell-Nr. Order-No.	G	Druck Press.	Einb.-Ø Fitt.-Ø	Passend für Suitable für
1	541293	1/4"	3/15bar	66mm	Solenry
2	541249	1/4"	3/15bar	65mm	Marcfi/Ancas



Abb. Pict.	Bestell-Nr. Order-No.	G	Druck Press.	Einb.-Ø Fitt.-Ø	Passend für Suitable für
1	541223	1/8"	2,5/16bar	60mm	Astoria, Espresso, Spaziale, Wega
2	541262	1/8"	3/15bar	63mm	Astoria
3	541202	1/8"	3/15bar	60mm	Faema



Abb. Pict.	B.-Nr. O.-No.	G	Druck Press.	Rahmen Frame	Einb.-Ø Fitt.-Ø	Passend f. Suitable f.
1	541263	1/8"	2,5/16bar	48x37mm	63mm	Astoria
2	541266	1/8"	2,5/16bar	48x37mm	63mm	Bezzera
3	541234	1/8"	2,5/15bar	60x47mm	63mm	Auora



Abb. Pict.	Bestell-Nr. Order-No.	G	Druck Press.	Einb.-Ø Fitt.-Ø	Passend für Suitable für
1	541285	1/8"	3/15bar	60	Marzocco
2	541233	1/8"	2,5/15bar	60	Nuova Simonelli
3	541287	1/8"	2,5/15bar	60	Pavoni



Abb. Pict.	B.-Nr. O.-No.	G	Druck Press.	Rahmen Frame	Einb.-Ø Fitt.-Ø	Passend f. Suitable f.
1	541256	1/8"	2,5/15bar	60x47mm	58mm	Brasilia
2	541269	1/8"	2,5/15bar	60x47mm	58mm	Brasilia
3	541273	1/8"	2,5/15bar	60x47mm	58mm	Brasilia

## Manometer

### Manometers

Doppelskala/Double scale



Abb. Pict.	B.-Nr. O.-No.	G	Druck Press.	Rahmen Frame	Einb.-Ø Fitt.-Ø	Passend f. Suitable f.
1	541267	1/8"	2,5/15bar	60x47mm	60mm	Brasilia
2	541279	1/8"	2,5/20bar	60x47mm	63mm	Conti
3	541224	1/8"	2,5/16bar	60x47mm	63mm	Spaziale



Abb. Pict.	B.-Nr. O.-No.	G	Druck Press.	Rahmen Frame	Einb.-Ø Fitt.-Ø	Passend f. Suitable f.
1	541294	1/8"	3,5/6bar	60x47mm	60mm	Unic
2	541295	1/8"	3,5/20bar	60x47mm	60mm	Unic
3	541209	1/8"	2,5/16bar	67x47mm	60mm	Rancilio



Abb. Pict.	B.-Nr. O.-No.	G	Druck Press.	Rahmen Frame	Einb.-Ø Fitt.-Ø	Passend f. Suitable f.
1	541259	1/8"	3/15bar	60x47mm	60mm	Bezzera
2	541257	1/8"	2,5/15bar	60x47mm	58mm	Brasilia



Abb. Pict.	B.-Nr. O.-No.	G	Druck Press.	Rahmen Frame	Einb.-Ø Fitt.-Ø	Passend f. Suitable f.
1	541203	1/8"	2,5/15bar	60x47mm	63mm	Faema
2	541288	1/8"	2,5/15bar	60x47mm	63mm	Pavoni

## Schrauben/CNS (V2A)

### Screws/stainless steel (V2A)

VPE 20 Stück/Pack 20 pieces



Abb. Pict.	Bestell-Nr. Order-No.	Größe Size	VPE/Stück Pack/pieces	DIN-Norm
1	560216	5 x 20mm	20	963
1	560219	6 x 14mm	20	963
1	560273	6 x 16mm	20	963
2	560270	5 x 23mm	30	966
2	560271	5 x 14mm	20	966
2	560272	5 x 16mm	20	966
3	560084	5 x 16mm	20	933
3	560274	5 x 25mm	20	933



Abb. Pict.	Bestell-Nr. Order-No.	Größe Size	VPE/Stück Pack/pieces	DIN-Norm
1	560275	5 x 8mm	20	933
1	560276	5 x 12mm	20	933
2	560025	4 x 10mm	20	912
2	560031	6 x 10mm	20	912
2	560032	6 x 14mm	20	912

## Hilfsmittel

### Useful accessories



Abb. Pict.	Bestell-Nr. Order-No.	Beschreibung Description
1	802109	Milchaufschäumer, 1/2" Milk foamer, 1/2"
2	802110	Milchaufschäumer, 1/8" (CNS) Milk foamer, 1/8" (stainless steel)



Abb. Pict.	Bestell-Nr. Order-No.	Beschreibung Description
1	802104	Kaffepulverpresse (Nylon) Coffepowder press (nylon)
2	802113	Kaffepulverpresse (Aluminium) Coffepowder press (aluminium)
3	802103	Kaffeelöffel (Kunststoff) Coffeespoon (plastic)

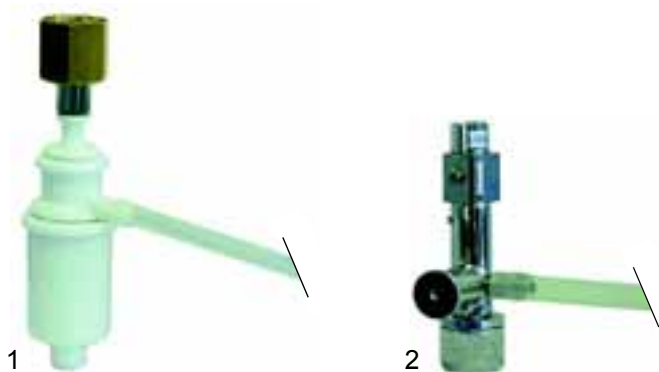

Abb. Pict.	Bestell-Nr. Order-No.	Beschreibung Description
1	802101	Probedruck-Manometer, 3/8" Test pressure manometer, 3/8"
2	802102	Reinigungsbürste Cleaning brush

## Hilfsmittel

### Useful accessories



Abb. Pict.	Bestell-Nr. Order-No.	Beschreibung Description
1	802115	Digitalwaage, 100g Digital balance, 100g
2	802116	Thermometer/50 - 260°C Thermometer/50 - 260°C



Abb. Pict.	Bestell-Nr. Order-No.	Beschreibung Description
1	541097	Analogthermometer/-10 - 100°C Analogous thermometer/-10 - 100°C
2	541096	Digitalthermometer/-50 - 150°C Digital thermometer/-50 - 150°C



Pos. Item	Bestell-Nr. Order-No.	Beschreibung Description
1	802120	Kaffeemesskoffer/kpl. (Digitalwaage, Thermometer, Kaffepulverpresse, Prüfmanometer mit Siebträger, Reinigungsbürste, Wasserhärte-Messtest) Coffeemeasuring bag/cpl. (Digital balnce, thermometer, coffepowder press, testing manometer with filter holder, cleaning brush, water hardness-measuring test)

## Hilfsmittel

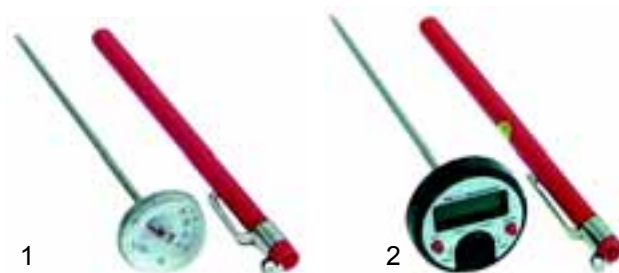
### Useful accessories



Abb. Pict.	Bestell-Nr. Order-No.	Beschreibung Description
1	802111	Milchaufschäumerreiniger, 1Liter Cleaner for milk foamer, 1 liter
2	530097	Entkalkungsmittel, 50g Beutel Calcium remover, 50g pouch
2	530098	Entkalkungsmittel, 200g Beutel Calcium remover, 200g pouch
2	530099	Entkalkungsmittel, 1000g Beutel Calcium remover, 1000g pouch
3	802117	Puly clean baby, 10 Beutel Puly clean baby, 10 pouch
4	802118	Entkalkungsmittel, 1 kg Dose Calcium remover, 1 kg box



Abb. Pict.	Bestell-Nr. Order-No.	Beschreibung Description
1	950010	Kaffeersatzreiniger, 900g Dose Coffee ground cleaner, 900g box
2	802106	Kaffeersatzreiniger, 15 Beutel Coffee ground cleaner, 15 pouch
3	802107	Kaffeersatzreiniger, 60 Tabletten Coffee ground cleaner, 60 tablets

### Etolit produkte/Etolit products



Abb. Pict.	Bestell-Nr. Order-No.	Beschreibung Description
1	802124	Entkalkungsmittel, 1000g Dose Calcium remover, 1000g box
2	802123	Tee- und Kaffeeiniger, 1000g Dose Tea- and coffeecleaner, 1000g box
3	802122	Milchaufschäumer und Sahnespender, 1Liter Milk foamer and cream dispenser, 1 liter

### Loctite produkte/Loctite products



Abb. Pict.	Bestell-Nr. Order-No.	Beschreibung Description
1	890058	Flüssige Rohrgewindedichtung Liquid gasket
2	890063	Hochfeste Schraubensicherung Very firm bolt protection
3	890136	Sekundenkleber, 3g Tube Moment adhesive, 3g tube
4	890078	Sekundenkleber, 5g Flasche Moment adhesive, 5g bottle

### Schmiermittel (KTW-Zulassung) Lubricants (FDA-registration)



Abb. Pict.	Bestell-Nr. Order-No.	Beschreibung Description
1	890087	Silikonfett, 25g Tube Silicon fat, 25g tube
1	890101	Silikonfett, 75g Tube Silicon fat, 75g tube
2	890119	Armaturenfett, 25g Tube Fitting fats, 25g tube
3	890118	Armaturenfett, 14g Tube Fitting fats, 14g tube
4	890116	Armaturenfett, 60g Tube Fitting fats, 60g tube

### Innenbürsten Inner brushes



in mm			Abb. CNS/Best.-Nr. Stainl. steel/ Order-No	Abb. Nylon/Best.-Nr. Nylon/Order-No.
D	L	A		
4	300	100	1 801451	2 801461
6	300	100	1 801452	2 801462
8	300	100	1 801453	2 801463
10	300	100	1 801454	2 801464
12	300	100	1 801455	2 801465
15	300	100	1 801456	2 801466
20	300	100	1 801457	2 801467

## Hilfsmittel

### Useful accessories

#### Filterkörbe/Filter baskets



Pos. Item	B.-Nr. O.-No.	VPE Pack	Maße Dim.	Gerätetyp Device type	Vergl.-Nr. Comp.-No.
1	960100	1000 Stck. 1000 pcs.	84/250mm	Mondo, Matic, Nova, Th, RL-Serie	7150101103 7150101108
2	960105	500 Stck. 500 pcs.	110/360mm	B5, B5HW, AM112	7150102301
3	960102	500 Stck. 500 pcs.	152/437mm	B10, B10HW	7150103301
4	960103	500 Stck. 500 pcs.	175/525mm	B26, B20HW	7150104301
5	960104	500 Stck. 500 pcs.	280/635mm	B40, B40HW	7150105301

#### Filterpfannen/Filter pans



Abb. Pict.	B.-Nr. O.-No.	Beschreibung Description	Passend für Suitable for
1	950100	Universal-Filterpfanne mit Dauerfilter Universal filter pan with permanent filter	Animo, Bonamat, Melitta
2	960095	Messkanne, 2 Liter Measuring can, 2 liters	Animo, Bonamat, Melitta

#### Steckfüße/Plugging feet



Abb. Pict.	Bestell-Nr. Order-No.	D1/ mm	D2/ mm	H/ mm	Passend für Suitable for
1	802130	40	10	16	Kaffeemaschinen Coffee-maker
2	802134	20	12	9	Kaffemühle Coffee grinder
3	802133	24	8	4	Motorpumpe Engine pump

#### Steckfüße/Plugging feet



Abb. Pict.	Bestell-Nr. Order-No.	Maße Measures	G G	H/ mm
1	802131	40x40mm	M10	30
2	802132	Ø 42/32mm	M10	52 - 70



Pos. Item	Bestell-Nr. Order-No.	G	D/ mm	H1/ mm	H2/ mm
1	690830	M8	24	8	34
2	690831	M8	24	8	54
3	690832	M10	24	8	34
4	690833	M10	24	8	54

#### Dampfrohwasserschutz/Steam pipe water cover

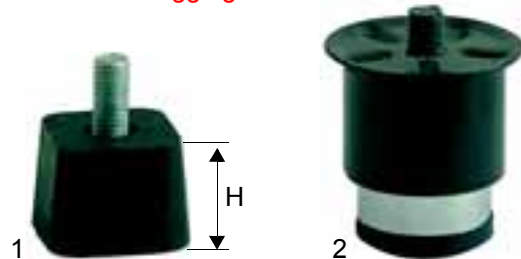
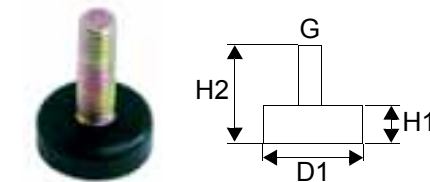

Abb. Pict.	Bestell-Nr. Order-No.	Beschreibung Description
1	528625	Gummischlauchschutz Rubber hose protection
2	529626	Pinzette/kurz Tweezers/short
3	529627	Pinzette/lang Tweezers/long

## Manuelle Wasserenthärter Hand water softener

### Legende:

FI Flascheninhalt in Lit.  
HI Harzmengeninhalte in Lit.  
SV Salzverbrauch pro Regen.  
K Kapazität bei 17°DH

### Abbreviations:

FI Cylinder contents in lit.  
HI Resin amount in lit.  
SV Salt consumption f. regen.  
K Capacity at 17°DH

### Technische Daten:

Betriebsdruck: max. 7bar  
Wassertemperatur: 2 bis 40°C  
Anschluss: 3/8"

### Technical data:

Operating pressure: max. 7bar  
Water temperature: 2 - 40°C  
Connection : 3/8"



Abb. Pict.	B.-Nr. O.-No.	FI	HI	SV	K	HxD (mm)
1	530120	8 L.	5,8 L.	1 kg	1000 L.	185 x 415
1	530121	12 L.	9 L.	1,5 kg	1500 L.	185 x 515
1	530126	16 L.	12 L.	2 kg	2100 L.	185 x 615
1	530127	20 L.	15 L.	3 kg	3100 L.	185 x 915
2	530122	8 L.	5,8 L.	1 kg	1000 L.	185 x 415
2	530123	12 L.	9 L.	1,5 kg	1500 L.	185 x 515
2	530124	16 L.	12 L.	2 kg	2100 L.	185 x 615
2	530125	20 L.	15 L.	3 kg	3100 L.	185 x 915
3	530195	7 L.	5 L.	1 kg	1100 L.	175 x 380
3	530196	10 L.	7 L.	1,5 kg	1500 L.	175 x 420
3	530197	12 L.	8 L.	2 kg	1700 L.	175 x 510

### Ersatzteile MB/MM/Spare parts MB/MM



Abb. Pict.	Bestell-Nr. Order-No.	Beschreibung Description	Für Typ For type
1	520133	Ventil, 3/8" Valve, 3/8"	MB
2	520135	Bypassventil Bypass valve	MM
3	530328	Düse, M6 x 1 Nozzle, M6 x 1	MB
4	520213	Reduzierung, 3/8" - 3/4" Reduction, 3/8" - 3/4"	MB, MM
5	520214	Reduzierung, 3/8" - 3/4" Reduction, 3/8" - 3/4"	MB, MM

### Ersatzteile MB/MM/Spare parts MB/MM



Abb. Pict.	Bestell-Nr. Order-No.	Beschreibung Description	Für Typ For type
1	520130	Deckel/kpl. Cover/cpl.	MB, MM
2	520131	O-Ring ( Deckel ) O-ring (cover)	MB, MM
3	530128	Plastsockel Plastic base	MB, MM



Abb. Pict.	Bestell-Nr. Order-No.	Beschreibung Description	Für Typ For type
1	520132	Filter/oben/Filter above	MB
1	520269	Filter/oben/Filter above	MM
2	520134	Filter/unten/Filter below	MB
2	520140	Filter/unten/Filter below	MM 8L
2	520141	Filter/unten/Filter below	MM 12L
2	520142	Filter/unten/Filter below	MM16L
2	520143	Filter/unten/Filter below	MM20L

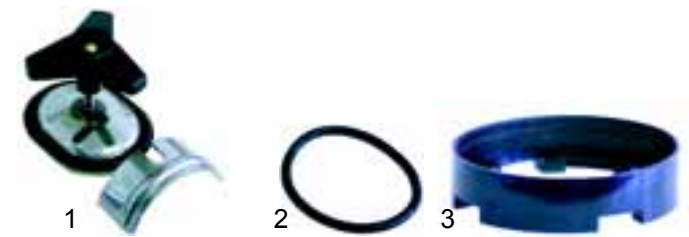

Abb. Pict.	Bestell-Nr. Order-No.	Beschreibung Description
1	520136	Harz Dowex HCR -S/S, 25 Liter Resin Dowex HCR -S/S, 25 liter
1	530240	Harz Purolite 25 Liter Resin Purolite 25 liter
2	540620	Gesamthärte-Maßbesteck Devices for water hardness measur. (overall hardness)
2	540621	Karbonathärte-Maßbesteck/ Devices f. water hardness measur.(carbonate hardness)



## Automatischer Wasserenthärter Automatic water softener

### Legende:

FI Flascheninhalt in Lit.  
HI Harzmengeninhalt in Lit.  
SV Salzverbrauch pro Regen.  
KS Kapazität Salzbehälter  
K Kapazität bei 17°DH

### Abbreviations:

FI Cylinder contents in lit.  
HI Resin amount in lit.  
SV Salt consumption f. regen.  
KS Capacity salt cylinder  
K Capacity at 17°DH

### Typ AZB

#### Technische Daten:

Betriebsdruck: 2 bis 5 bar  
Temperatur: 2 bis 40°C  
Versorgung: 230V/50Hz  
Intervall: 1 bis 6 Tage  
Steuerung: Bores/Zeitsteuerung

#### Technical data:

Operating pressure: 2 bis 5 bar  
Temperature: 2 - 40°C  
Feeding : 230V/50Hz  
Interval: 1 to 6 days  
Regulation: Bores/Time regul.



Abb. Pict.	B.-Nr. O.-No.	FI	HI	SV	KS	K	BxTxH (mm)
1	530138	8 L.	6 L.	1,1 kg	20 kg	1300 L.	230 x 430 x 490
1	530139	12 L.	9 L.	1,5 kg	50 kg	1900 L.	310 x 430 x 590

### Typ AZA

#### Technische Daten:

Betriebsdruck: 1,8 bis 7 bar  
Temperatur: 2 bis 45°C  
Versorgung: 230V/50Hz  
Intervall: 1 bis 6 Tage  
Steuerung: Autotrol/Zeitsteuerung

#### Technical data:

Operating pressure: 1,8 bis 7 bar  
Temperature: 2 - 45°C  
Feeding : 230V/50Hz  
Interval: 1 to 6 days  
Regulation: Autotrol/Time regulation



Abb. Pict.	B.-Nr. O.-No.	FI	HI	SV	KS	K	BxTxH (mm)
1	530130	8 L.	6 L.	1,1 kg	20 kg	1300 L.	245 x 480 x 560
2	530131	12 L.	9 L.	1,5 kg	30 kg	1950 L.	310 x 430 x 660
2	530132	20L.	15 L.	2,7 kg	70 kg	3250 L.	310 x 430 x 1100

### Typ AVA

#### Technische Daten:

Betriebsdruck: 2 bis 6 bar  
Temperatur: 2 bis 40°C  
Versorgung: 230V/50Hz  
Steuerung: Autotrol/Volumetrisch

#### Technical data:

Operating pressure: 2 bis 6 bar  
Temperature: 2 - 40°C  
Feeding : 230V/50Hz  
Regulation: Autotrol/Volumetric

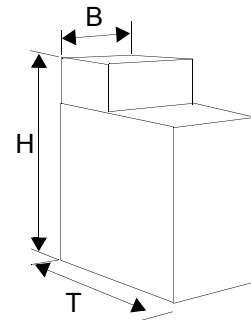

Pos. Item	B.-Nr. O.-No.	FI	HI	SV	KS	K	BxTxH (mm)
1	530133	12 L.	9 L.	1,5 kg	30 kg	1900 L.	310 x 490 x 660
2	530134	20 L.	15 L.	2,7 kg	70 kg	3200 L.	310 x 490 x 1100

### Typ AZFW

#### Technische Daten:

Betriebsdruck: 2 bis 6 bar  
Temperatur: 2 bis 60°C  
Versorgung: 230V/50Hz  
Intervall: 1 bis 6 Tage  
Steuerung: Fleck/Zeitsteuerung

#### Technical data:

Operating pressure: 2 bis 6 bar  
Temperature: 2 - 40°C  
Feeding : 230V/50Hz  
Interval: 1 to 6 days  
Regulation: Fleck/Time regulation



Pos. Item	B.-Nr. O.-No.	FI	HI	SV	KS	K	BxTxH (mm)
1	530190	12 L.	9 L.	1,5 kg	30 kg	1900 L.	310 x 490 x 660
2	530191	20 L.	15 L.	2,7 kg	70 kg	3200 L.	310 x 490 x 1100

### Typ AZV

#### Technische Daten:

Betriebsdruck: 2 bis 8 bar  
Temperatur: 5 bis 15°C  
Versorgung: 230V/50Hz  
Intervall: 1 bis 6 Tage  
Steuerung: DEV

#### Technical data:

Operating pressure: 2 bis 8 bar  
Temperature: 5 - 15°C  
Feeding : 230V/50Hz  
Interval: 1 to 6 days  
Regulation: DEV



Abb. Pict.	B.-Nr. O.-No.	FI	HI	SV	KS	K	BxTxH (mm)
1	530129	8 L.	5,8 L.	1 kg	20 kg	1000 L.	245 x 430 x 490

## Ersatzteile AZB/Spare parts AZB



Abb. Pict.	Bestell-Nr. Order-No.	Beschreibung Description
1	530304	Ventiloberteil/kpl./Valve upper part/cpl.
2	530303	Abdeckung/Cover
3	530300	Transformator, 230V/24V - 12VA
4	530301	Getriebemotor (Stunden)/Gear engines (hours)
4	530305	Getriebemotor (Minuten)/Gear engines (minutes)
5	530302	Mikroschalter/Microschalter

## Ersatzteile AZA, AVA/Spare parts AZA, AVA



Abb. Pict.	Bestell-Nr. Order-No.	Beschreibung Description	Typ Type
1	530032	Ventiloberteil/kpl., Zeitsteuerung Valve upper part/cpl., time control	AZA
2	530034	Timer, Zeitsteuerung Timer, time control	AZA



Abb. Pict.	Bestell-Nr. Order-No.	Beschreibung Description	Typ Type
1	530033	Ventiloberteil/kpl., volumetrisch Valve upper part/cpl., volumetric	AVA
2	530040	Timer, volumetrisch Timer, volumetric	AVA
3	530042	Zähladapter Counting adapter	AVA

## Ersatzteile Universal/Spare parts universal

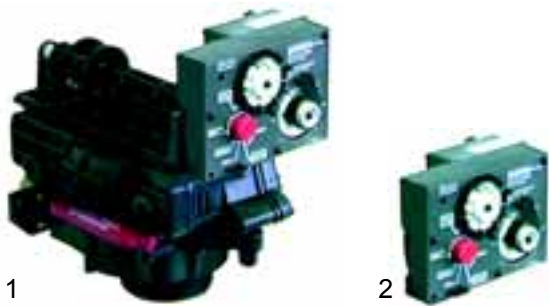

Abb. Pict.	Bestell-Nr. Order-No.	Beschreibung Description
1	530324	Kit-Membrane/Kit-membrane
2	530325	Kit-Bypass/Kit-Bypass

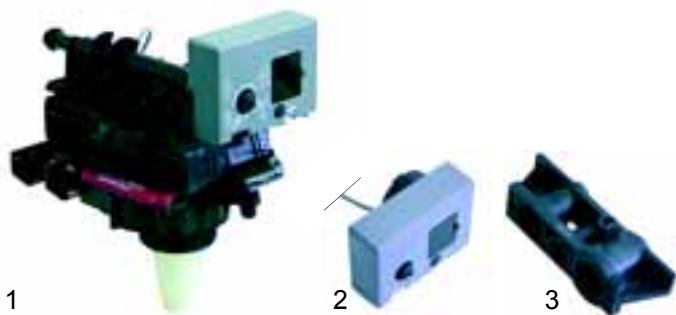
## Ersatzteile AZFW/Spare parts AZFW



Abb. Pict.	Bestell-Nr. Order-No.	Beschreibung Description
1	530267	Ventiloberteil/kpl./Valve upper part/cpl.
2	530266	Ventiloberteil/Valve upper part



Abb. Pict.	Bestell-Nr. Order-No.	Beschreibung Description
1	530260	Elektronik/Electronics
2	530261	Tasten/Push buttons
3	530262	Abdeckung/Cover



Abb. Pict.	Bestell-Nr. Order-No.	Beschreibung Description
1	530263	Transformator, 230V/24V
2	530264	Getriebemotor, 24V/Gear engine, 24V
2	530268	Getriebemotor, 230V/Gear engine, 230V

# Mechanische Teile/Mechanical parts

## Ersatzteile AZFW/Spare parts AZFW

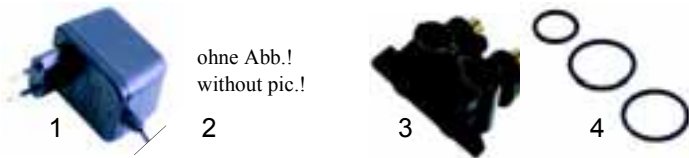

ohne Abb!  
without pic.!

Abb. Pict.	Bestell-Nr. Order-No.	Beschreibung Description
1	530041	Transformator, 230V/12V, 6VA
2	530330	Getriebemotor, 12VAC/Gear engine, 12VAC
3	520300	Bypass-Ventil, Bypass-valve
4	520318	O-Ring-Satz/O-ring-set



Abb. Pict.	Bestell-Nr. Order-No.	Beschreibung Description
1	530035	Ventiloberteil/Valve upper part
2	530036	Nockenwelle/Camshaft
3	530037	O-Ring-Satz/O-ring-set
4	530038	Luftventilhaube/Pneumatic valve cover
5	530026	O-Ring (Lufthaube)/O-ring (pneumatic valve cover)



Abb. Pict.	Bestell-Nr. Order-No.	Beschreibung Description
1	530311	O-Ring/O-ring
2	530312	Filter
3	530316	Kugel/Ball
4	530315	O-Ring/O-ring
5	530313	Rückspülventil (7)/Return rinse valve
5	530314	Rückspülventil (8)/Return rinse valve
6	530317	Injector (weiß)/Injector (white)
6	530318	Injector (blau)/Injector (blue)
6	530319	Injector (rot)/Injector (red)
7	530320	Kappe/Cap
7	530321	Kappe/Cap
7	530322	Kappe/Cap
8	530323	Solemengenregler/Brine quantity controller

## Ersatzteile DEV/Spare parts DEV



Abb. Pict.	Bestell-Nr. Order-No.	Beschreibung Description
1	530135	Satzbehälter/Grounds container
2	530136	Flaschenüberzug/Cylinder cover
3	520309	CNS-Flasche/Stainless steel cylinder
4	530128	Plastsockel/Plastic base
5	530030	Abdeckung/Cover
6	520138	Deckel/Cap

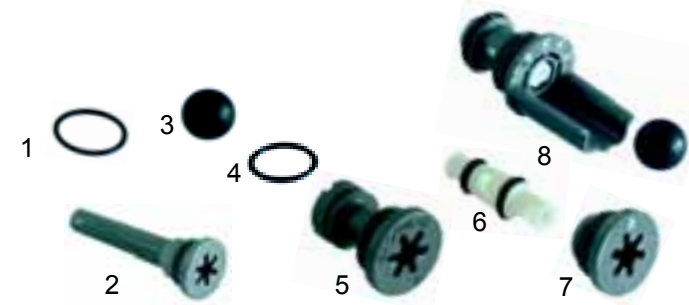

Abb. Pict.	Bestell-Nr. Order-No.	Beschreibung Description
1	520301	Verschraubung Sauglanze Salzbehälter/ Salt tank intake lancette stock
2	520302	Sauglanze Salzbehälter/Salt tank intake lancette
3	520307	Verschraubung Behälter/Salt tank stock
4	520315	Sauglanze CNS-Flasche/ Intake lancette CrNi-cylinder
5	520303	Nylonschlauch/Nylon cover
6	520306	Überlaufverschraubung/Overflow stock



Abb. Pict.	Bestell-Nr. Order-No.	Beschreibung Description
1	530029	Ventiloberteil/Valve upper part
2	520305	Elektronikbox, 230V/Electronic box, 230V

## Ersatzteile DEV/Spare parts DEV



Abb. Pict.	Bestell-Nr. Order-No.	Beschreibung Description
1	530043	Magnetspule/Magnetic coil
2	530277	Ventilkörper/Valve body
3	530287	Solemengenregler/Brine quantity controller
4	530282	O-Ring/O-ring
5	530283	O-Ring/O-ring
6	530294	Düse/Nozzle
7	530286	Oberteil/Upper part
8	530293	O-Ring/O-ring
9	530284	O-Ring/O-ring
10	530288	O-Ring/O-ring

Abb. Pict.	Bestell-Nr. Order-No.	Beschreibung Description
1	530297	O-Ring/O-ring
2	530292	Feder/Spring
3	530291	Buchse/Nut
4	530289	Stift/Pin
5	530281	Körper/Body
6	530283	O-Ring/O-ring
7	530280	Membrane
8	530295	Feder/Spring
9	530296	O-Ring/O-ring
10	530279	Körper/Body

## Harze Resins

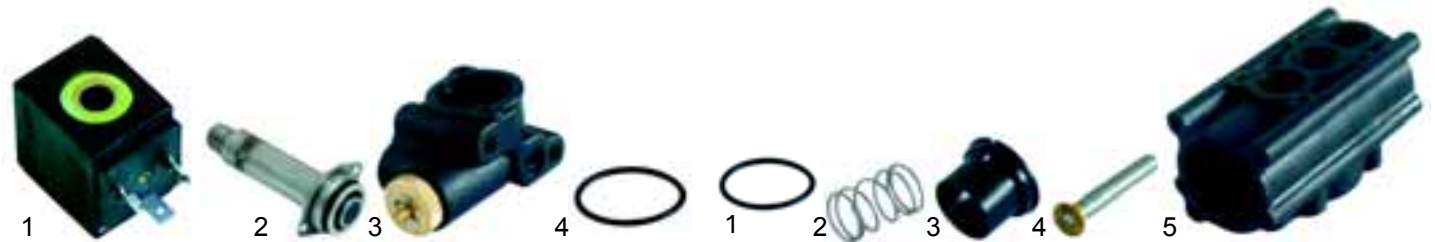
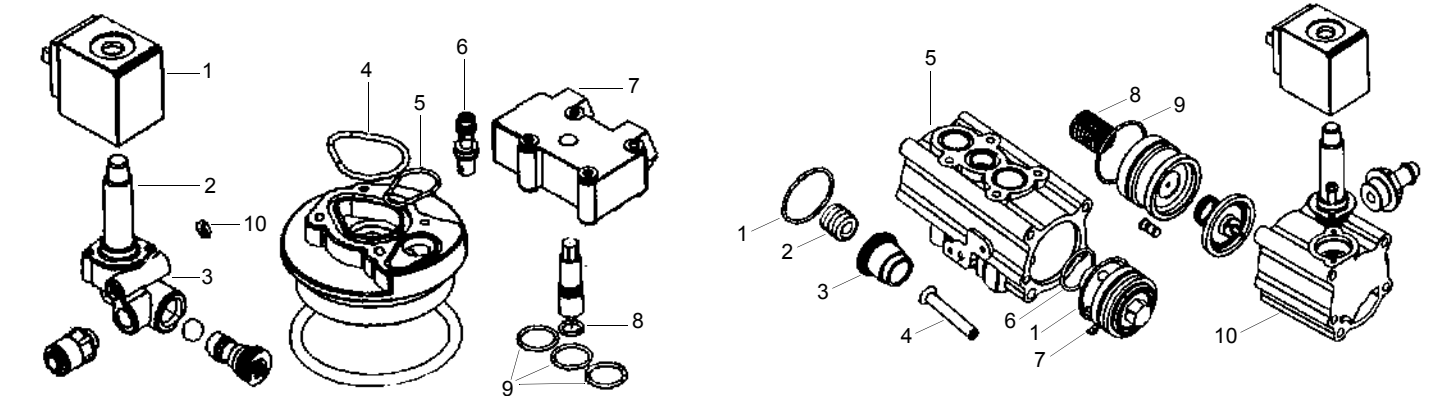

Pos. Item	Bestell-Nr. Order-No.	Beschreibung Description
1	520136	Dowex HCR -S/S, 25 Liter Dowex HCR -S/S, 25 liter
1	530240	Purolite 25 Liter Purolite 25 liter

## Wasserhärte-Maßbesteck

### Devices for water hardness measuring



Pos. Item	Bestell-Nr. Order-No.	Beschreibung Description
2	540620	Gesamthärte Overall hardness
2	540621	Karbonathärte Carbonate hardness